

Building Has Evolved®

INSTALLATION MANUAL

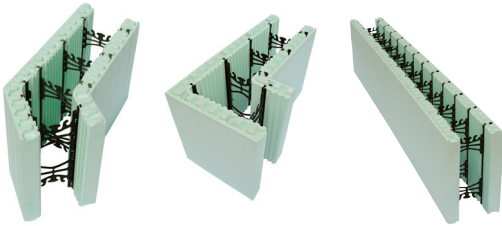

Tools | Site Prep | Product Assembly | Install Procedures | Waterproofing & Parging | Electrical, Mechanical & Plumbing | Interior & Exterior Finishes



INSTALLATION VIDEOS

Go to nudura.com/installationvideos to watch NUDURA's installation videos

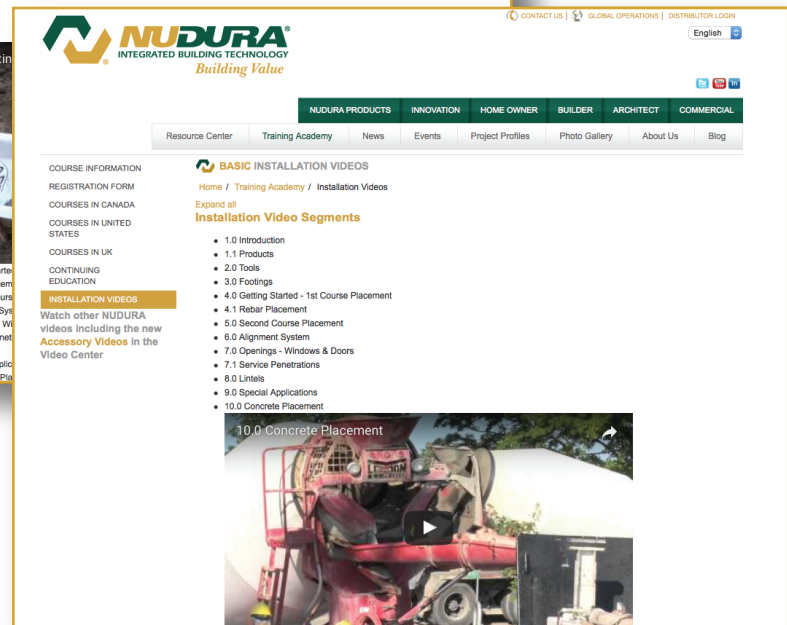
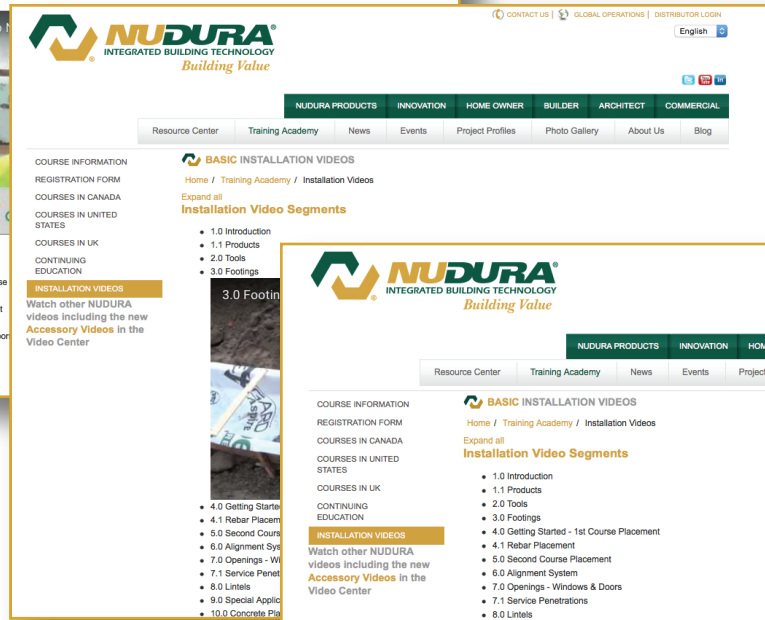

INSTALLATION MANUAL

Published June 2017

All material valid at time of print.

Please visit www.nudura.com for installation manual updates.

© 2017 NUDURA® Inc.



DISCLAIMER NOTICE

The information contained in this Installation Manual is presented as a “Guide Only” to the installer for the purpose of assisting them in more easily adopting the use of the NUDURA® Insulated Concrete Wall Forming System (“NUDURA®”) in lieu of more traditional wall construction methods. Where aspects of any building design stray outside of or beyond the scope of prescriptive design as established by this manual AND adopted Building Codes for your region, this Manual SHALL NOT be used as a substitute for professional engineering consultation.

This manual mainly focuses on residential building techniques; while the methods used in commercial construction are similar, commercial buildings may have special requirements not detailed in this manual. Be sure to consult relevant building codes and specifications before proceeding with any project to ensure all applicable regulations are observed. To avoid injury, comply with local safety regulations, and follow ALL tool and material MANUFACTURERS’ INSTRUCTIONS and SAFETY GUIDELINES.

Detailing formats, material composition, and references contained herein have been formulated to reflect general infield residential installation practices and to suit the majority of standards as endorsed by most North American building codes. The manual additionally features selected details in the Appendix Sections that reflect foundation, floor and roof details commonly found in the United Kingdom, Ireland, France and most other European countries

as well. The reinforcing formats shown in detailing are suggested formats for general installation reference only, and are subject to amendment or modification by any Design Engineer of Record. Final reinforcing steel bar diameter, placement and spacing remain the sole responsibility of the Engineer of Record for the project in question. It is the Engineer’s and Contractor’s sole responsibility to assure that details and reinforcing have been designed and installed in full compliance with the provisions of all local and applicable governing codes and standards.

NUDURA® makes no general warranties to the specific applicability of any of the contained details to any or all situations for which the designer may elect their specific use. Final amendment or modification to suit the exact circumstance of employment of such details is the responsibility of the project designer.

NUDURA® will not be responsible for the installation or workmanship used in the assembly or the installation of NUDURA®. Therefore, NUDURA® shall not be liable for any general, special, direct, indirect or consequential damages, including, but not limited to, bodily harm that may be suffered by any person including, without limitation, the installer, contractor, architect, engineer, homeowner or customer due to the use, assembly or installation of NUDURA®.

GLOSSARY OF TERMS FOR UK AND IRELAND

20 MPa - 20 KN (Newton Strength)

Brick Ledge - Corbel

Catwalk - Platform

Extension Cords - Extension Leads

Footings - Footers, Foundations

Gypsum - Plasterboard

HRV (Heat Recovery Ventilation) - MHRV (Mechanical Heat Recovery Ventilation)

Lumber - Timber

Parging - Rendering

Pruning Shears - Secateurs

Scaffold - Platform

Screws - Fixings

Sill Plate - Wall Plate

Sill Gasket - DPC or Treated Lumber

Straightened - Adjusted

Waterproofing - Tanking

TABLE OF CONTENTS

GLOSSARY OF TERMS

1.0 INTRODUCTION	1.1 Preface	7
	1.2 Technical Support	7
	1.3 NUDURA Website	7
	1.4 Introduction to NUDURA Integrated Building Technology Product Series	7 11
2.0 GETTING STARTED	2.1 Drawing & Contract Document Preparations	13
	2.1.1 Guidelines for Reinforcing Steel	14
	2.1.2 How to Design Walls & Lintels Using Appendix D & E	17
	2.1.3 Required Wall Thickness	23
	2.1.4 Layout Planning	24
	2.1.5 Wall Height Charts	29
	2.2 Estimating	32
	2.2.1 Imperial Formulas	32
	2.2.2 Metric Formulas	39
	2.2.3 Concrete Volumes	46
	2.3 Building Permit Submission Requirements	48
	2.4 Evaluation Reports	49
	2.5 Building Department Typical Expectations	50
	2.6 Pre Construction Planning	51
3.0 TOOLS	3.1 Standard Construction Tools	53
	3.2 Standard Concrete Tools	53
	3.3 NUDURA Recommended Tools	53
	3.4 Miscellaneous Supplies	53
	3.5 Construction Materials List	54
	3.5.1 Below Grade Materials	54
	3.5.2 Above Grade Materials	54
	3.5.3 Roof Connection Materials	54
4.0 SITE PREPARATION & DELIVERY	4.1 Preplanning of Site	55
	4.2 Backfill Placement	55
	4.3 Truck Access for Material Delivery	55
	4.4 Product Storage and Protection from Damage	55
	4.5 Boom Truck Positioning	56
	4.6 Concrete Truck Access	56
	4.7 Safety	56

5.0 NUDURA PRODUCTS	5.1 Product Packaging	57
	5.2 NUDURA Alignment System	61
	5.3 NUDURA FORM-LOCK	62
	5.4 Vertical Joint Clips	62
	5.5 V-Clips	63
	5.6 Form Transition Bracket	63
	5.7 NUDURA Spray Foam	64
	5.8 Masonry Ties	64
6.0 INSTALLATION PROCEDURES	6.1 Footings	65
	6.2 First Course Placement	69
	6.3 Second Course Placement & Leveling	73
	6.4 Additional Course Placement	74
	6.5 Openings	74
	6.6 NUDURA Alignment System	80
	6.7 Service Penetrations	83
	6.8 Vertical Reinforcing Steel Placement	84
	6.9 Special Applications	85
	6.10 Concrete Specifications and Placement	93
7.0 DAMPROOFING/ WATERPROOFING	7.1 Peel and Stick Membrane	97
	7.2 Disclaimer on Product	98
	7.3 Material Storage	98
	7.4 Installation	98
	7.5 Warranty	99
8.0 PARGE COAT	8.1 Mixing Instructions	101
	8.2 Installation Instructions	102
	8.3 Finishes to Parge Interfacing	103
9.0 OPENINGS	9.1 Opening Preparations	105
	9.2 Window & Door Installations	107
	9.3 Flashings/ Drip Edges	108
10.0 ELECTRICAL	10.1 Code Compliance	111
	10.2 Through Wall Penetrations	111
	10.3 Panel Location	111
	10.4 Wire Chases	112
	10.5 Electrical Boxes	112
	10.6 Electrical Wiring	113
	10.7 Conduit	113
	10.8 Recessed Lighting with Ceiling Technology	114

INSTALLATION MANUAL

11.0 MECHANICAL		115
12.0 PLUMBING		117
13.0 INTERIOR FINISHES	13.1 Vapor Barrier/Vapor Retarder Requirements	119
	13.2 Thermal Barrier Protection	119
	13.3 Finishes and Trim Options	120
	13.4 Post Occupancy Fixture Mounting Tips for Home & Building Owners	121
14.0 EXTERIOR FINISHES	14.1 General	125
	14.2 Finish Materials	126
APPENDIX A	Form Unit Details	131
APPENDIX B	Typical Cross Sections	143
APPENDIX C	Typical Details-North America	161
	Typical Details-International	187
APPENDIX D	Reinforcing Tables-USA	201
	Reinforcing Tables-Canada	219
APPENDIX E	Lintel Tables-USA	241
	Lintel Tables-Canada	269
APPENDIX F	Technical Bulletins	301

1.1 PREFACE

Your consideration of NUDURA Integrated Building Technology for your next design project is the right choice for today's complex design challenges. NUDURA's unique concrete form wall system sets it firmly apart from other Concrete Forming Products on the market. NUDURA is leading the way, showing designers, engineers, and contractors an advanced approach to both residential and commercial building design solutions. NUDURA's award winning technology and energy efficiency means a faster and more efficient building approach that outperforms most other conventional wall types.

NUDURA Inc. continues to demonstrate why it is at the forefront of the construction Industry through its competitive pricing and vast product distribution network. NUDURA handles its products exclusively through a dedicated network of regionally deployed building product distributors, who are prepared to advise you on every aspect of project execution.

1.2 TECHNICAL SUPPORT

Technical Support is available through your local distributor. The distributor is your first line of contact for assistance as they can best identify with your local applicable codes and conditions common to your region. To locate your local distributor please contact NUDURA Inc. at:

Email: info@nudura.com
Phone: 866-468-6299 (Toll free within North America)
Or: +705-726-9499 (Direct Dial from anywhere)

Phone service is available between 8:00 AM and 4:30 PM Eastern Time

1.3 NUDURA WEBSITE

www.nudura.com

The NUDURA website is a valuable tool for designers, engineers, and contractors. There you will find the most recent updates on our manuals, public access testing reports, evaluation reports, technical bulletins and current news. The construction professional section of the website is a great source of information for all of your construction questions. Should additional information be required, please contact your local distributor.

1.4 INTRODUCTION

What is NUDURA Integrated Building Technology?

NUDURA Integrated Building Technology is a building product system that combines a comprehensive array of building products that are dedicated to enabling designers and builders alike to create one of the most flexible and energy efficient building envelope systems available on the market today. As outlined in the NUDURA Product Manual, The system includes:

The NUDURA Wall Form System (including all of its related accessory products)
NUDURA Floor Technology and
NUDURA Ceiling Technology

These products when used together in any building structure, enable the designer and builder to create building envelopes that when combined with a properly designed mechanical system, are statistically known to provide end users with living environments that can deliver substantial savings on annual energy costs over conventionally constructed frame or CMU constructed buildings.

INTRODUCTION

If you are a designer or builder who has never worked with Insulated (or Insulating) Concrete Form Technology before, this manual (in combination with the NUDURA Installation DVD), will prove to be an invaluable guide in designing and working with NUDURA Forms. If you have never worked with Insulated Concrete Forms before, you will find many advantages over conventional building material design and construction.

THE FORM

NUDURA Insulated Concrete Forms consist of two lightweight 2 5/8" (67 mm) uniform thickness expanded polystyrene (EPS) foam plastic panels manufactured to a nominal EPS foam density of 1.35 pcf (21.6 kg/m³). The EPS panels are connected together with either integrally molded foldable high-density polypropylene hinged web/fastening strips or injection molded high-density polystyrene fastening strips interlinked with high-density polypropylene insert webs. Additional features include full height fastening strips every 8" (203 mm).

The NUDURA wall system completes 6 building steps with one product providing:

1. The concrete form system
2. Wall structure (structural reinforced monolithic concrete)
3. Insulation
4. Air barrier
5. Vapor barrier
6. Interior and exterior finish anchorage

Having six wall elements in one product eliminates costly building steps, and allows the building project to be constructed faster and more efficiently.

For those of you that are perhaps familiar with insulated concrete form systems trying NUDURA for the first time, you will find several features that set NUDURA clearly apart from other insulated concrete form systems.

DURAMAX TECHNOLOGY®

NUDURA forms are double the length of most other insulated form systems. While most systems feature forms at 4' (1.22 m) in length, NUDURA Forms are a full 8' long (2.44 m). In addition, the form height is set at 18" (457 mm) to optimize horizontal steel placement to it's maximum permitted extent under prescriptive design for 6" (152 mm) core walls. This means that every time an installer is placing a form, they are placing a full 12 ft² (or 1.115 m²) of formwork in one motion.

4-WAY REVERSIBLE SYSTEM

All of the NUDURA Form line-up feature top and bottom edges and are molded with a robust, continuous, fully reversible interlock. This means superb flexibility infield, automatically doubling form usage whenever a half height form may be required, enormously less waste when constructing gable end walls, since both halves of the cut form can be used and the best part – no left and right corners to have to worry about having on hand during construction.



FIGURE 1.03

DURALOK TECHNOLOGY®

Besides the reversible interlock of the EPS panel edges, the embedded web/fastening strips run the full 18" (457 mm) height of each and every form, end cap and height adjuster accessory. Each fastening strip is embedded in the EPS at consistent 8" (203 mm) intervals and are recessed 5/8" (15.9 mm) from the surface. Each fastening strip is also fitted at the top and bottom edges with a patented reversible triple tooth interlock.



FIGURE 1.01



FIGURE 1.02

Combined together, these features enable every form to solidly lock together in field, preventing form separation during concrete pour and enabling easy stacking and interlocking of the form system. No longer are forms dependent on simply EPS to EPS foam contact for assembly. This minimizes separation of the EPS forms along the horizontal joints, and eliminates form compression during concrete placement, resulting in rapid, solid construction, less form support having to be installed, and in the end, straight and plumb walls. Further, no longer does form settlement have to be planned for at openings in the construction of the wall system.

The webs connecting to the fastening strips across the concrete core also have openings to permit concrete to pass through, and feature a variety of seat options for support and locking of horizontal steel reinforcing bars.

DURAFOLD TECHNOLOGY®



FIGURE 1.06

One of the best features of all is NUDURA's patented hinge folding mechanism. This allows for efficient shipping, convenient packaging, and the forms arrive at the site flat for efficient on site storage. With a simple opening technique, they can be hinged open instantly for use. 4 steel hinge pins on each web are the secret, and these serve to solidly hold the form at its required shape once opened. The flat ship format enables the forms to be shrink wrapped and bundled with 3 forms to a package with a finished bundled weight of approximately 45 lbs (20.41 kg).

This means in one trip, and single handedly, an average worker can easily transport 36 ft² (3.32 m²) of wall form from the truck to the storage area. The flat format also means super efficient on site storage as well. In the same space it takes to store 2 skids of standard 8" (203 mm) concrete blocks (enough to construct 134 ft² (12.5 m²) of wall area) 10 bundles of NUDURA formwork can be stored for a total 360 ft² (33.4 m²) of wall area (almost 3 times as much). Even more amazing - the corner forms fold for shipping and storage as well, through use of NUDURA Insert Web Technology.

The same insert web technology provides even more flexibility to the NUDURA System as the system can be purchased as either fully assembled forms or as a knock-down system of panels and insert webs. BOTH technologies can be married to each other in-field to suit almost any building application (or in-field build problem) imaginable.

OTHER FEATURES AND BENEFITS

NUDURA walls provide a fire resistance rating of up to 4 hours (ULC Listed, UL Classified), a Sound Attenuation of min. STC 50 (for 6" (152 mm) core and above), as well as an insulation value of R-23.59 (RSI 4.14). The EPS foam combined with the concrete mass, results in a potential for the wall assembly to perform equivalently to a low mass wall assembly insulated to a level of R- 50 (depending upon geographic location).

COMPREHENSIVE FORM AND ACCESSORY SYSTEM

The NUDURA form system is among the most comprehensive form systems available on the market today enabling the construction of the following core cavity thicknesses of walls,

- 4 " (101 mm)
- 6 " (152 mm)
- 8 " (203 mm)
- 10 " (254 mm)
- 12 " (305 mm)



FIGURE 1.04



FIGURE 1.05



FIGURE 1.07

INTRODUCTION



In ANY core thickness, the following form profiles are available for the construction of walls in any desired configuration:

- Standard (straight run wall) Form Units
- 90 degree Corner Form Units
- 45 degree Corner Form Units
- T-Form Units (enabling the construction of 25 possible combinations of thickness main wall and T wall intersection across the 5 core thicknesses of forms)
- Taper Top Form Units (enabling concrete to approach the exterior or interior (or both) edges of the form at its top edge)
- Brick Ledge Form Units (for creating corbelled ledges for support of brick or stone masonry veneers)
- Brick Ledge Extension Forms (enabling creation of brick ledges at ANY desired height or angle)
- End Caps (for capping end wall runs or window/door openings)
- Height Adjuster Forms (enabling the adjustment of form stacking to an incremental height difference of 3" (76 mm) or 12" (305 mm) if required to suit an application)
- Factory Cut Radius Forms (site assembled forms which are factory cut to suit any custom installation, enabling the construction of NUDURA forms for ANY desired plan radius formation)

In addition to the above core products, NUDURA Inc. also has over 30 accessory products to enhance the already state of-the-art form system. A list of these accessories is available in Chapter 5 of this manual.

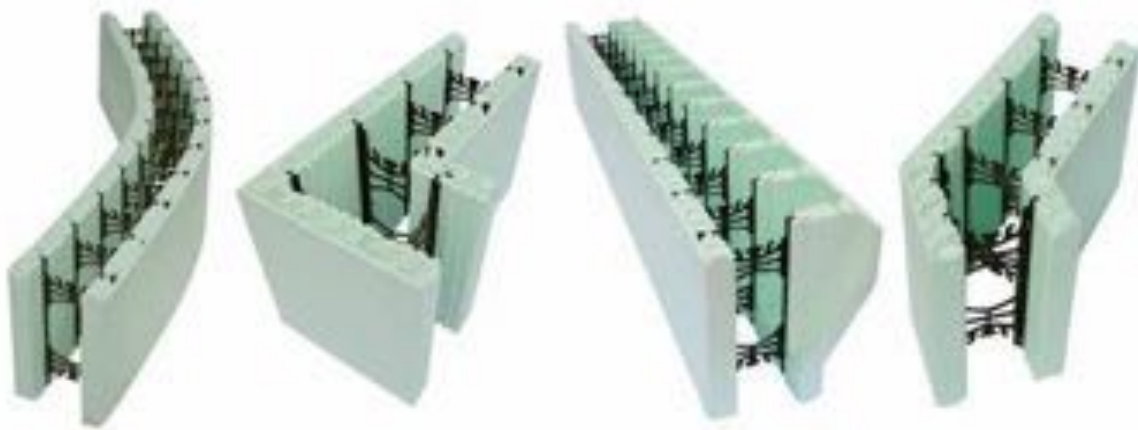

FIGURE 1.08

This manual covers off installation methods with NUDURAs ICF Series of products. NUDURA offers other innovative series (One Series, Plus Series and Integrated Series) that complement and enhance the NUDURA ICF Series. For more information on the above series visit nudura.com.





NUDURA ICF SERIES

The NUDURA ICF Series is the leader in insulated Concrete Form Innovation and Technology and offers users the ability to combine a variety of products during the building process. The NUDURA ICF Series offers unique advantages over other products currently on the market.

DURAMAX Technology®
DURAFOLD Technology®
DURALOK Technology®
The 4-Way Reversible System



ONE SERIES

The One Series is the industry's only multi-link form system that enables the creation of a fully exposed concrete surface that extends to the face of a standard NUDURA form panel. This offers builders and architects unmatched versatility for projects designed to use ICFs. At the core of this innovative line is our DURA MULTI-LINK™, a newly designed web that enables the builder to create custom multisided form combinations for a variety of commercial and residential building projects.



PLUS SERIES

The Plus Series product line introduces an innovative way for designers and engineers to build their own R-value. Comprised of two new products, the Plus Form and the R-Value Plus+ Insert, this product line offers the ability to optimize R-Value with thermal mass to provide significant energy savings for building owners. The NUDURA Plus Series allows professionals the ability to meet new installation requirements with one product.



INTEGRATED SERIES

The Integrated Series from NUDURA combines building envelope products that work in conjunction with our line of Insulated Concrete Forms to provide maximum energy efficiency. Each Integrated Series product has been manufactured to install quickly and efficiently and replaces many traditional forms of insulation products that are far more labor intensive.



To download the most up to date version of the NUDURA Product Guide go to nudura.com/brochures.

2.0 GETTING STARTED



FIGURE 2.01

To help ensure a project starts on the right foot, in this section, NUDURA has compiled some helpful tips to help guide your building design, contract documentation, basic structural analysis, layout and elevation planning, estimation techniques and formulae and finally requirements for a typical permit submission involving NUDURA product as well as tips on pre-construction planning specific for a NUDURA building site. Following these steps should help to avoid delays when submitting your documents for building permit approval, and start your project on its way to a smooth and efficient build.

The permit applicant (usually the contractor) is ultimately responsible for communicating with, and ensuring that, the building department has the required information to process and issue a permit for a proposed project.

2.1 DRAWING & CONTRACT DOCUMENT PREPARATIONS

A smooth permit submission starts with the project drawings. Whether the project is starting from scratch in planning for use of NUDURA or you are converting a drawing set from conventional construction to NUDURA, the building official will need to see sufficient documentation to corroborate that NUDURA is being used on the project and how it is specified and detailed.

First, determine the size and scope of your proposed building design and prepare your drawing set (or contact a local draftsman or AutoCAD designer) to reflect the fact that the building is being constructed using NUDURA Integrated Building Technology. NUDURA's experience has shown that there is nothing that gets a Building Official more incensed than a contractor or designer attempting to substitute a building system or component on a set of plans or building site that has not been properly referenced or documented on the permit application documents. Here are a few guidelines on what to include that will help the Building Official be more accepting of the submission documents:

- (a) Notes on the basement floor plan, either stand alone or indicating by arrow, to the foundation wall:
 - The Form Unit Core Thickness proposed for the installation
 - The Horizontal Bar Diameter and required c/c spacing (per the Governing Code Data, NUDURA Structural Data or Evaluation Report, usually 18" o/c (457 mm) or at floor levels and every other course at minimum if permitted by code)
 - The Vertical Bar Diameter and required c/c spacing (reference back to the design tables for the local region– below grade)
 - Indicate that the vertical steel will project 20" to 24" (500 mm to 600 mm) above the first pour to stub into the main level wall cavity
 - Indicate that footing dowels of minimum #4 (USA) or 10M (CAN) bar at a maximum of 24" (600 mm) o/c, or #5 (USA) or 15M (CAN) bar at a maximum 48" (1220 mm) along the footing centre line and project into the foundation wall above the footing a minimum of 8" (200 mm)
- (b) Notes on the main and any subsequent floor plan either stand alone or indicating by arrow to the exterior walls:
 - The Form Unit Core Thickness
 - The Horizontal Bar Diameter and required c/c spacing (usually 18" o/c (457 mm) or reference the tables for the local region or Evaluation Report)
 - The Vertical Bar Diameter and required c/c spacing (reference the tables for the local region or Evaluation Report)

GETTING STARTED

- Indicate how the floors will be attached to the NUDURA wall (rim joist bolts, ICF Connect etc) and attach any corroborating data from the manufacturer or applicable code for spacing of these attachments. If a second floor is required, indicate that the vertical steel will project between 20" and 24" (508 mm and 610 mm) above the first pour to stub into the 2nd level wall cavity
 - Indicate the roof truss sill anchor bolts diameter & spacing
- (c) For all floor plans (including foundation plan), indicate at each window the required specifications for the lintels intended to be installed. These will include:
- The number, and diameter of the bottom horizontal bars in the lintel
 - The stirrup end distance (SED - the distance in from the edge of the opening that the stirrups start). Refer the Building Official to the installation manual diagram or perhaps staple a copy to the drawings to show the lintel cross section
 - The stirrup spacing back to the jamb from the SED, (see the lintel table notes in appendix E)
 - The overall height of the lintel
 - Indicate on the plan with a dashed line (i.e. _____) the fact that the bottom and top horizontal steel of the lintel extends 24" (610 mm) beyond the edge of the openings
 - As an alternate to including the above notes at each window, a lintel schedule which the openings can be referenced to can be created, similar to a Window Schedule Layout. This method of notation is preferred

2.1.1 GUIDELINES FOR REINFORCING STEEL DESIGN AND PLACEMENT

In preparing drawings, the most important difference between typical poured concrete walls and NUDURA walls is the fact that the walls are reinforced walls. Under most building codes, NUDURA is classified as a "Flat Wall ICF System" meaning that it enables the creation of flat monolithic structural reinforced concrete walls contained within the form system.

HOW NUDURA STEEL PLACEMENT DIFFERS FROM CONVENTIONAL POURED WALL REINFORCEMENT DESIGN

In considering flat wall design using NUDURA Insulated Concrete Forms, it is best to consider the wall in exactly the same manner as all performance based building codes do – it is simply a structurally reinforced monolithic flat concrete wall with insulation mounted to both sides of the poured wall.

1. **MINIMAL TIE WIRING.** Though selected details of steel tying may be required at custom column or beam installations or around openings, the primary assembly of steel occurs without the use of tie wiring. Instead, NUDURA relies on features built into its web or cross tie design to enable the wall to be constructed by relying on the "Non-contact Lap Splice" method of reinforcing for both horizontal and vertical steel placement as is provided for under Section 12 of ACI 318 in the USA and CAN/CSA A23.1 and A23.3 in Canada. Under most code bodies all non-contact lap splices installed must be lapped a minimum lap splice length of 40 times the bar diameter. This falls under the applicable concrete codes for monolithic concrete walls which this distance is based on requirements for bundled bars laps in flexural members as per ACI 318 Section 7.6.6.4 and CAN/CSA A23.3 Section 7.4.2.3. In addition, the lapped bars must not be positioned greater than 1/5th of the lap splice length apart or any further apart than 6" (152 mm). (Section 12.14.2.3 of both ACI 318 & CSA A23.3).

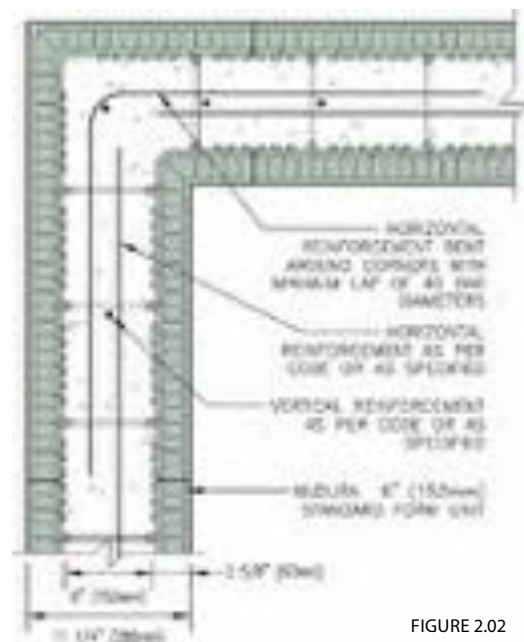

FIGURE 2.02

2. **ORDER OF STEEL PLACEMENT.** Unlike traditional forming, where the steel grid is cross wired together prior to the final form face being installed, NUDURA wall reinforcing steel proceeds with placement of HORIZONTAL steel being laid in, in non-contact splice fashion, course by course as the form units (or blocks) are installed around the wall in bond stacking fashion. Corners and T form Wall connections, again, will normally feature non-contact lap splice connections (unless specific requirements of the design parameters for a local condition would dictate otherwise). VERTICAL steel placement then proceeds once coursing heights have reached either the top of each floor height of wall being installed (in multi-story installations) or (in the case of a staged single story tall height wall pour) at the designated termination drop height as dictated by the engineer (typically between 8' and 12' (2.4 m and 3.6 m in height). In these instances, the steel is cut by the installer to ensure a 40 times bar diameter non-contact lap splice with the level of floor being installed above it.

3. **NO TIE WIRING AT FOOTINGS.** Again, as adopted within most building codes, the footing dowels are in place to resist lateral movement at the base of the wall section through the installation of wet set dowels which extend from the footing into the base of the wall to be installed over it. The assembly order of the vertical steel requires that they be placed AFTER the wall is installed to full floor course height. This also dictates that there is NO requirement for the contractor/installer to provide tie wiring of the vertical steel to the footing (footer) dowels. Hence, a non-contact lap splice between the footing (footer) dowels and the wall steel is required at this junction.

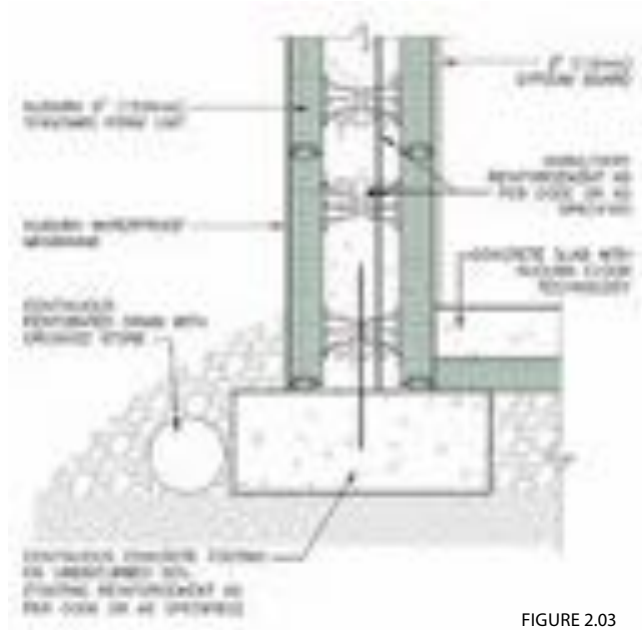

FIGURE 2.03

HORIZONTAL STEEL PLACEMENT METHOD

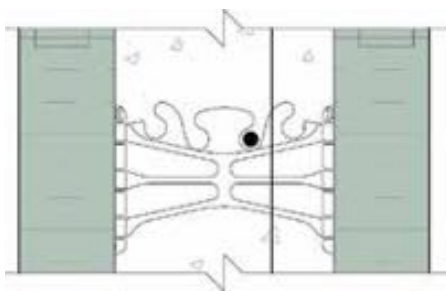

FIGURE 2.04

NUDURA's unique web design allows the contractor/installer the ability to precisely locate reinforcing steel within the wall cavity, ensuring the rebar stays in the optimal required location, thus maximizing the strength of the complete concrete wall. (See Fig. 2.04) This is enabled by notches or capture lugs that are molded into the top and bottom of each cross tie connecting web, which allows the contractor/installer to accurately install the horizontal reinforcement bars within the concrete core in accordance with the Engineer's specifications. This eliminates the requirement of tie wiring the horizontal reinforcement bar in the correct location specified by the Engineer (in fact, enabling placement as close as $\frac{3}{4}$ " (19 mm) from the inside face of the form). This improves overall strength performance of the wall assembly which gives the design professional the comfort level of knowing the reinforcing steel has been cast in exact locations as specified.

NOTE: In the diagram (Fig. 2.04), for a 6" (152 mm) core form, there are 4 pairs of horizontal steel capture lugs per connection web, each of the lugs being positioned approximately $\frac{3}{4}$ " (19 mm) apart. This design feature is typical across the form line design for each cavity width of form available - with the wider forms providing more options for steel placement as space permits. The $\frac{3}{4}$ " (19 mm) gap is the secret to enabling vertical steel to be installed once course installations are completed (see Vertical Steel Placement Method under this Section).

HORIZONTAL STEEL SPECIFICATION TIPS

- NUDURA forms are manufactured to a course height of 18" (457 mm). Therefore, for efficient on-site installation, always specify horizontal reinforcing at no denser a placement than 18" (457 mm) o/c. (Adjust vertical reinforcing density so that this 18" (457 mm) module can be maintained horizontally).
- If EXTRA horizontal reinforcement should be required (i.e. for higher seismic zones), consider moving to a higher diameter bar or – as a last resort, consider specifying placement of bar at the top AND bottom of a form unit.
- As per installation instruction, detailing would typically show the horizontal reinforcing oscillating from one lock position (of the pair of reinforcing steel cradles) to the other between horizontal lap splices. As installation proceeds up the wall, the installer will install the steel in the course immediately above in exact opposite positioning of the course below, in such a way that at every course (every 18" (457 mm)), horizontal bar will be capturing either one side of the vertical steel or the other as per positioning specification by the engineer (see Figure 2.05a).
- The placement of the horizontal steel can secure the vertical steel in the center and either the tension or compression side of the wall.
- To take full advantage of the accuracy of steel placement, the engineer may detail horizontal steel placement to position the vertical steel to occur:
 - (a) Towards the tension (usually towards the "inside" of a below grade wall)
 - (b) Towards the outside (tension side) of a foundation wall containing back fill higher than the prevailing grade around it or if installed as a non-laterally supported retaining wall
 - (c) To the center of an above grade wall anticipating wind loading from multiple directions (as shown in Fig. 2.05b)

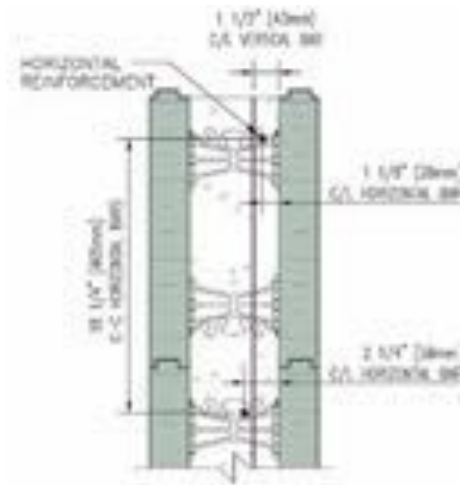

FIGURE 2.05a

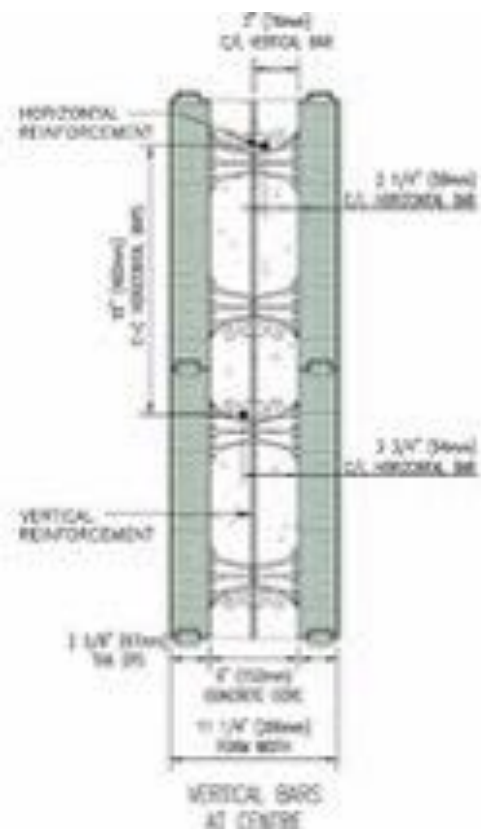

FIGURE 2.05b

VERTICAL STEEL PLACEMENT METHOD

NUDURA's cross connecting web ties are preformed into the EPS panels at 8" (203 mm) o/c increments. To optimize vertical steel placement, a NUDURA Trained Installer is instructed to do 3 things:

- (a) Ensure that the forms are placed with ALL webs being in vertical alignment with each other.
- (b) Feed vertical steel downward into the wall such that it will be WOVEN into the central ¾" (19 mm) gap that is formed by the oscillating placement of the horizontal steel courses (as noted above)
- (c) Install vertical steel so that it occurs adjacent to a web on the side from which concrete is intended to be first placed into the wall. This means that as the concrete pushes against the vertical steel, the pressure of the concrete will drive the steel against the web and the web will prevent the vertical steel from moving out of alignment during the pour (hence, no tie wiring required)

By following the vertical steel specification tips given below, the design professional will guarantee that the installer will be able to best optimize accurate and rapid steel installation within the NUDURA wall system.

VERTICAL STEEL SPECIFICATION TIPS

Using the above installer techniques as a guide, remember that reinforcing steel proceeds MOST efficiently if specified on vertical grids that are multiples of 8" (203 mm) on center. (i.e. 8, 16, 24, 32, 40, 48" (203, 406, 610, 813, 1016, 1219 mm) o/c).

If the design calculation requires vertical steel at increments not within the 8" (203mm) spacing of the web, NUDURA recommends that the designer consider doubling every other reinforcement bar or to vary the bar diameter. This achieves the same required cross sectional area of steel in order to meet the design specifications.

When dealing with a cold joint, it is recommended to wet set dowels into the concrete as deep as 40 times the diameter of the reinforcement bar using a non contact lap splice. This will facilitate an easier in-field build than more traditional methods which require joint level access for tie wiring. Always remember that vertical steel is placed AFTER the wall is constructed to the designated construction height and prior to concrete placement.

2.1.2 HOW TO DESIGN WALLS AND LINTELS USING APPENDIX D AND E

Anyone already familiar with either the prescriptive methods employed in the design tables featured in either the USA International Residential Code (Section R404 and R611) or in NBC Codes 2005 and later under Section 9.17 and 9.20 can skip this information. However, if needed, you can always refer to this method if instructing someone new on how to use the Structural Design Tables contained in Appendix D and E of this manual.

Why use separate tables from Code Published Prescriptive Data? The Tables contained in Appendices D and E have been designed to conform to exactly the same concrete standards and limits as the IRC and NBC Code Tables conform to. However, NUDURA's Engineers have designed these tables to ideally work with the specific geometry of the NUDURA Form System (i.e. form unit heights of 18" (457 mm) and vertical web spacing at 8" (203 mm) on center and core thicknesses exactly matching the available form unit thicknesses of NUDURA's form line-up).

IMPORTANT NOTES

1. Remember that the Design Tables have been based on the design methods adopted for prescriptive design for residential construction (single family residences, townhouse or one and two family homes) in either Canada or in the USA ONLY, and in conformance with the allowable limits under the applicable code sections or the applicable evaluation report for each country.

GETTING STARTED

2. Similar to the majority of prescriptive data available in North America, NUDURA's Structural Tables (Appendix D for Wall Design and E for Lintel Design) have been prepared basing design on 2 key elements:

Minimum Concrete Compressive Strength shall be: 3,000 lb/in² or 20 MPa

Minimum Yield Strength of Reinforcing Steel shall be: 60 kips/in² or 400 Grade

3. Remember as well that the Engineers who have designed these tables have spelled out clear limitations to their use in the notes preceding the tables, limiting such things as maximum allowable live and dead loads, truss and floor span limits, roof slope, number of storeys above (maximum 2) and below (maximum 1) grade, even maximum allowable plan dimension, (in exact conformance with the prescriptive limits of the applicable Code). NUDURA's engineers have assured that the selected design options will exceed the minimum reinforcement requirements for each country. However, please note that the designer/builder remains fully responsible for the CORRECT usage of these tables in applying the design parameters required to yield the final results.

BELOW GRADE WALL DESIGN = APPENDIX D

The designer needs to know 5 pieces of data:

1. The desired core thickness that the client wishes to be used in the design (always start with 6" (152 mm)).
2. The maximum height of the wall from the top surface of the footing to the underside of the floor joist connection to the wall.
3. The height of backfill being placed against the wall. This is defined as the distance from the top of the basement floor slab to the maximum level of the backfill outside of the basement.
4. The general type of soil condition anticipated for the site, whether it will be gravel/sand, sand loam mix, or clay or silt mix. The designer or builder should consider the worst case scenario if a combination of these soils is expected on site.
5. The seismic zone classification for the site. (Depending on location this may or may NOT effect the design of below grade walls since backfill stresses tend to far outweigh seismic effects).

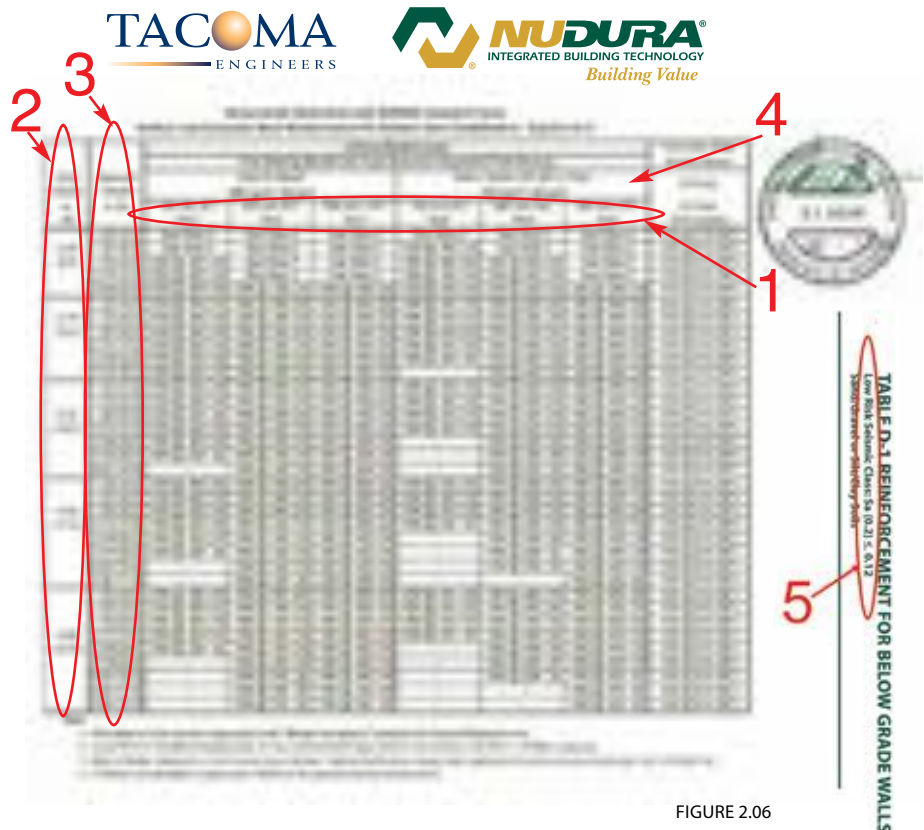

FIGURE 2.06

PROCEDURE

1. Knowing above information, from the Below Grade Design Tables select the correct design table from the options available (based on desired core thickness (6, 8 or 10" (152, 203, or 254 mm)) and seismic risk (Low or High)).
2. Once the table has been selected, from the 2 left hand columns of the table, identify the required wall height and backfill height for each wall condition.
3. Next select the appropriate set of columns corresponding to the prevailing soil type at your site.
4. Note the required reinforcement for the condition at the corresponding cell to your required backfill height and desired core thickness of concrete. If there is NO notation, it means that you must select a higher core thickness of concrete.
5. If after repeating the scenario for both 8" (203 mm) and 10" (254 mm) core thicknesses, no scenario is able to be located to satisfy the requirement, a structural engineer will have to be contracted to complete the design to suit the condition.

ABOVE GRADE WALL DESIGN = APPENDIX D

As in Below Grade Design, the designer again needs to know 5 pieces of data:

1. The desired core thickness that the client wishes to be used in the design (Unless there are tight spatial considerations, always start with 6" (152 mm)).
2. Whether the wall being considered is one of 3 scenarios
 - (a) The TOP floor of a one or two storey NUDURA building
 - (b) The BOTTOM storey of a NUDURA Building with light framed 2nd storey and roof
 - (c) The BOTTOM storey of a FULL two storey NUDURA Building
 The 3rd scenario will usually require denser, or more, reinforcement than the first 2 scenarios.

3. The maximum height of the wall from the top surface of the ground floor to the underside of either the ceiling joists or roof trusses of either the 1st or 2nd floor.

4. The seismic condition anticipated for the site. (The higher the classification, the more steel will be required in the design.) This data can be gleaned from the applicable Building Code or identified by the local Building Official for your region.

5. The wind speed (or design wind pressure) for the site. Again, the higher the wind pressure, the more severe the steel placement or increased the bar diameter will be. Like the seismic data, you can obtain this pressure from the Building Code or your local Building Official.

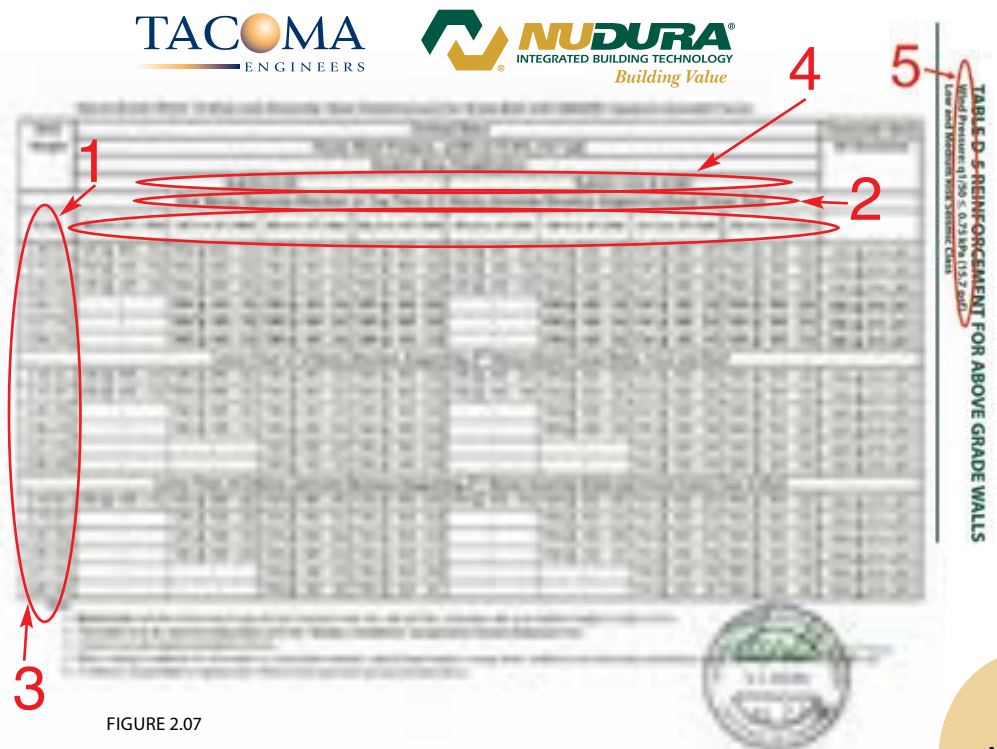

PROCEDURE

1. Knowing above information, from the Above Grade Design Tables select the correct design table from the options available, (based on wind pressure and seismic zone thickness (Low, Medium or High to the maximum condition noted). If your scenario is not listed, a professional engineer **MUST** be contracted to complete the design.
2. Once the table has been selected, from the left side of the table, identify the required wall height for your design from the very left hand column of the table.
3. Next, select the appropriate set of columns corresponding to the prevailing seismic zone of your site.
4. Finally, select your desired wall core thickness.
5. Note the required reinforcement for the condition at the corresponding cell to your required wall height and desired core thickness of concrete. If there is NO notation, it means that you must select a higher core thickness of concrete.
6. If no scenario can be located to satisfy the requirement after testing all subsequent core thicknesses, as in the Below Grade Tables, a structural engineer will have to be contracted to complete the design to suit the site condition.

LINTEL REINFORCEMENT DESIGN

Similar to the Wall Design Tables found in Appendix D, the Lintel Reinforcing Steel Design Tables in Appendix E apply to residential buildings **ONLY** that conform to the statement of limitations applied to the Prescriptive Design Requirements for Flat Wall Insulating Concrete Forms as noted in the IRC (USA) and under Part 9 of the NBC (CAN) (i.e. light frame roofs and light framed floor systems).

IMPORTANT NOTES REGARDING LINTEL DESIGN

Again, the Designer is cautioned to carefully review the design limits and notes that precede the Lintel Design Tables to assure that they fully understand what the limitations for application are. Of special importance within these notes is the fact that the tables are designed to resist **UNIFORMLY DISTRIBUTED LOADS ONLY**. Point loads as may be applied by girder trusses or beams have not been taken into consideration in the designs. In cases such as these, consideration should be made in your design to either:

- (a) Relocate the point load, if possible.
- (b) Relocate the opening.
- (c) If neither is possible, an engineer should be contracted to produce a stamped lintel design specific to the condition to carry the point load.

DETERMINING UNIFORMLY DISTRIBUTED LOADS

NUDURA's lintel tables differ somewhat from design data that may be contained in some Code Prescriptive Material in that the user must calculate the anticipated Uniformly Distributed Load (or UDL) condition for your lintel design. The following procedure outlines how this is accomplished.

1. First, if you are a design builder and you have already ordered or commissioned truss drawings or floor trusses for the project, the accompanying paperwork from the truss company or joist manufacturer can be used to automatically give you the required uniformly distributed loads at the reaction or bearing points of the truss or floor joist/truss without having to calculate yourself. If you don't have truss drawings or pre-engineered floor system drawings, you will have to calculate these loads yourself as outlined below.

2. First you need to determine the anticipated Live and Dead Loads for the building.

Dead Loads (or DL) are defined as any load that forms a permanent part of the building structure, such as joists, trusses, sheathing, shingles, tiles, etc. (these will typically fall anywhere between 5 to 15 lbs/ft² (24.41 kg/m² or 0.239 kPa). If floor or roof finishes demand heavier materials (such as tiles or slate) find out their densities/area of coverage and be sure to add these to your loads.

Live Loads (or LL) are defined as any load that will act on the structure temporarily. These include occupants and furniture for floors, wind and, most importantly, snow loads for roofs. This data is already set by your local Building Code. Just as you did for the seismic and wind data for your wall design, consult either the code or your local building official for the assigned climatic and live load data for your area.

Occupant live loads will vary with occupancy type. See the list below for some examples of how these loads can change. The chances are, if you are using NUDURA's tables for prescriptive design, you will only need to worry about residential live loads. However, if you are using the tables as a guide for quoting other work (that will involve engineer design at a later date) remember that lintel design for things such as offices, churches or theater type complexes will demand significantly more live load to be designed for, hence much more steel required for the lintels.

Residences: 40 lbs/ft² (195.30 kg/m² or 1.92 kPa)

Commercial: 50 lbs/ft² (244.12 kg/m² or 2.39 kPa)

Assembly: 100 lbs/ft² (488.24 kg/m² or 4.79 kPa)

3. Next, for each lintel condition, examine the opening condition in context to where it occurs in the building plan. (i.e. under a roof bearing or under a floor bearing condition). If the lintel condition is occurring in the bottom storey of a two storey building, although the roof condition in the storey above will exert some load, the majority of this load will be spread through the wall reinforcement occurring far above the lintel that's carrying the floor; the prominent load to be considered will be the condition immediately above the lintel (the floor load).
4. Note on the plan where the roof or floor trusses bearing onto the lintel span to the rest of the building. If it is a roof condition, chances are the roof truss may be spanning the full width of the plan. These are usually the most severe conditions of reinforcement. If the lintel will be carrying roof trusses, check whether or not there is a bearing wall in the middle of the floor plan carrying part of the roof truss. Note the dimensions of the span from the exterior bearing wall containing the opening, and the bearing condition on the opposite end of the truss or floor framing member.
5. If the opening is under a floor, the bearing point of the floor span will often be located in the middle of the building depth, particularly if standard floor joists are being used. In the case of engineered wood or framed floor systems (floor trusses), the spans will typically be longer, and perhaps will extend full depth/width of a floor plan to an exterior wall. Again, note the total span length of the structural member.
6. Now that you have the load data, calculating the uniformly distributed load (UDL) for your lintel conditions will be fairly easy. NUDURA's lintel tables have been designed to assign the safety factors FOR you. As a designer, you need not apply any additional safety factors for live or dead loads as these have been computed INTO the results on the tables. To calculate UDL use this simple formula:

$$\text{UDL} = (\text{Total DL} + \text{Total LL}) \times \frac{1}{2} \text{ the span member length}$$

The result will give you a load expressed in lbs per linear foot (or kg per linear meter) ready for use in the next section.

GETTING STARTED

THE LINTEL DESIGN PROCESS

To use the Lintel Design Tables, you will need to know 4 pieces of data. These include:

1. The lintel's concrete core thickness
2. The available height in the wall above the lintel
3. The width of the opening required to be spanned
4. The total UDL calculated from above

FIGURE 2.08

1. Select the appropriate Lintel based on the easy number system listed in the lower right corner of each Table. The first digit stands for the lintel core thickness- the second 2 digits after the dash indicate the height or depth of the lintel in "inches". For example, as noted in Figure 2.08, Lintel No. L6-15 means that it will be a lintel for a 6" (152 mm) thick wall that will be 15" (381 mm) deep when completed. A common strategy established by many designers or builders is to try and stick with a common lintel height that can be repeated around the building with a common stirrup height for a broad range of openings. This way, if stirrups are ordered pre-bent from a metal fabricator, all stirrups can be ordered the same height for the entire job without worry of which lintel they will be assembled into. For this reason, where possible, select the lintel height that will enable this to happen easily without compromising on strength requirement. Garage door and wide window openings may be the exception that requires a differing height of lintel.
2. On the left side of the Table, select the opening width required to be spanned. The Tables cover an opening range from 3'-0" (900 mm) up to as much as 20'-0" (6.0 m) where lintel depths permit.
3. On the right side of the table, select the column that corresponds to or EXCEEDS your required UDL load that you calculated in the previous section. Here the load options range from a low of 480 lbs/ft (7.0 KN/m) to a maximum of 2,395 lb/ft (35.0 KN/m).
4. At the cell corresponding to both opening width and load record the information indicated. This will give 2 pieces of data:
 - (a) The number and diameter of steel bars required for forming the bottom bar portion of the lintel
 - (b) The stirrup end distance required (measured from the opening jamb condition back towards the middle of the opening) at which to begin placement of the stirrups if they are required for the lintel

If the stirrup end distance is noted as 0-inches, this means that NO shear stirrups will be required to construct the lintel.

Notice that each Table features a thick diagonal line that runs upward generally from the lower left to the upper right of each table, subdividing the cell data of the table into 2 separate sections. Any scenario appearing above or left of this line will NOT require shear stirrups. Anything below and right of this line WILL REQUIRE shear stirrups.

5. The final element is stirrup spacing. This can always be found in the NOTES section appearing at the bottom of the applicable table you are working with, specific for any condition noted on that particular table.
6. Do not forget as well, that the notes also detail options for substitution of bars, should the contractor or builder NOT have a larger desired bar on site for construction of the lintels.
7. The final step is to record the above sets of data into a lintel schedule for presentation with the drawings.

2.1.3 REQUIRED WALL THICKNESS

Although the following information may not directly pertain to prescriptive design, this simple reference matrix is produced below (Figure 2.09) to assist engineers, designers and contractors alike in selecting an appropriate core thickness of NUDURA forms for optimum wall performance (i.e. to yield the most efficient combination of concrete and steel for required condition).

IMPORTANT NOTE: The recommendations contained in this document are intended as a general guideline only and should not be construed as a substitute for proper engineered design to ACI 318 (USA) or CAN/CSA A23.3 (CAN) Standards. Rather, this document is intended as a guideline to aid in selection of an appropriate form thickness for a suggested wall height or building type for budget, quotation or preliminary design consideration purposes ONLY.

In addition, also bear in mind that changes in the Canadian Concrete Design Standard in 2004 (CSA A23.3-04), may dictate larger core thicknesses than are projected by this table. For example, single warehouse or gymnasium heights of 22' to 25' (6.7 m to 7.6 m) previously found to be in conformance with slenderness ratios of the 1994 Code when constructed with 8 inch (203 mm) core walls MAY be required by your engineer to be larger than shown here if the design condition is close to the maximum heights shown in this table.

In addition, it is important to note that special local contributing factors such as high clay content in soils, high seismic velocities, or wind pressures in excess of 21 psf (20 mph to 40 mph) or 1.0 KPa (32 km/h to 64km/h) may dictate selection of a thicker core form if the design condition is close to the maximum heights suggested in this table. In most cases, the suggested recommendations herein will result in optimum reinforcing patterns capable of resisting the required loadings for each scenario. Wherever the term "Consult Engineering" is used, this suggests that one should consult professional design advice regarding the core thickness being considered for the height noted before making a decision to use the core thickness noted in the quotation or estimation.

FORM THICKNESS	BASEMENT/FOUNDATION LIMITS	SINGLE STOREY LIMITATION	MULTI STOREY LIMITATION	COMMON BUILDING TYPES
4" 102 mm	Basement not permitted Frost/Stem wall only. subject to engineering consultation	Safe to 10' > 10' Consult Engineering	2 stories 10' floor + gable end 12/12 pitch	Exterior walls of: houses – single, semi & townhouse, small offices single or 2 storey
6" 152 mm	8' – clay 9' – gravel 10' – Consult Engineering	Safe to 14' – 16' >16' – Consult Engineering	3 stories 4 with Eng. Design 10'-14' ht/floor	Almost any building type – maximum 16' single storey height without pilasters
8" 203 mm	9' – clay 10' – gravel 11' – Consult Engineering	Safe to 16' – 25' >25' – Consult Engineering	Lower 2-4 floors of 5-8 stories (use 6" on upper 2-3 stories)	Warehouses, theatres, church tall walls lower floors of hotels, condos, apartments
10" 254 mm	10' – clay 11' – gravel 12' – Consult Engineering	Safe to 25' – 35' >35' – Consult Engineering	Lower 2-4 floors of 9-12 stories	Under ground garages, theatre walls, fly lofts lower floors of hotels, condos, apartments
12" 305 mm	11' – clay 12' – gravel ≥13 Consult Engineering	Safe to 35' – 40' >40' – Consult Engineering	Consult Engineering	Heavy tall industrial applications deep foundation walls

FIGURE 2.09

2.1.4 LAYOUT PLANNING USING NUDURA FORMS

In the move from traditional wall systems to the use of NUDURA Integrated Building Technology in the construction industry, there are important elements for the contractor/installer to consider especially with respect to plan layouts.

First and foremost is the overall wall thickness. Unlike many other traditional walls, the exterior face of a NUDURA wall is located a full 2 5/8" (67 mm) distance from the concrete core it contains. Therefore, if an engineer specifies the exterior limit of his structure relative to a grid line, ensure that the architectural detail and plan always reflects that the exterior of the building is located such that the exterior insulation will lie outboard of the grid line, clear of this element.

The concrete core also has insulation on the interior face of the wall, which is located 2 5/8" (67 mm) from the inside face of the concrete core. This means that no matter what the structural drawings for the building show, the architectural plan will reflect a wall thickness that is 5 1/4" (133 mm) thicker than the actual concrete core.

Appendix A of this manual contains the form unit profiles for each unit available in the NUDURA lineup. Although each form in Appendix A is shown with a 6" (152 mm) concrete core, alternative core thicknesses are available and details for each of these can be obtained from NUDURA through your local distributor. The geometry in particular of the 90°, 45° and T Form Unit profiles dictate strongly the dimensions that will follow for "NUDURA Friendly" layout dimensions. These dimensions are based on 3 very important rules of on-site installation which are as follows:

1. Both corner units (45° and 90°) and T form Units are formed so that they can be bond stacked, course on course, with each other to create an ideal 16" (406 mm) overlap with the interfacing standards. This practice encourages consistency from course to course and maintains maximum strength in the construction of the wall for handling concrete pressures.
2. To maintain the geometry in Point 1 above, this manual teaches installer/contractors to avoid cutting corners or T Form Units, hence the layout tables reflect this philosophy. Only when designers require tight corner changes will the contractor/installer entertain cutting a corner form unit to achieve an in-field build. The reason NUDURA tries not to cut the corner forms is that under concrete pressure is increased pressure in these areas. This practice also better maintains an ideal offset of 16" (406 mm) when the corner forms are reversed on successive course placement, as shown in Figure 2.11.
3. The standard forms that are assembled within each course between the corners and T form units work best if the cut length of form occurs in multiples of 8" (203 mm). This assures that the vertical interlock of the webs will be maintained everywhere throughout the wall height. This is ideal for both the contractor/installer and the end user in that, at every location, the webs are assured to be in-line for drywall and other finish attachments both interior and exterior. This also allows the building owner or occupant to know where fastening is possible for the anchorage of decorative and storage elements. It should be noted that the wall can, if necessary, be constructed to ANY dimension required by the designer. However, optimum layouts will result best if the 8" (203 mm) increment recommendation is followed.



FIGURE 2.10



FIGURE 2.11

CORNER TO CORNER FORM LAYOUT SCENARIOS

On the basis of the key assumptions noted above, NUDURA has created layout tables for every core thickness of form offered, for planning scenarios, involving each of the wall profile intersections noted below. The number of tables necessary to cover scenarios by reference table for wall lengths up to 50' (15.24 m) is too numerous to publish in hard copy here. However, should the contractor/installer need a copy of these tables, please contact the local distributor.

Figure 2.12 is a typical example of how to use these tables to quickly identify the closest “NUDURA Friendly” dimension for the condition required for each wall segment of the proposed plan layout. In the instructions in each case remember that the scenarios given at the start of the tables indicate dimensions achievable if, and when, field condition demands that the corner form be cut.

IMPORTANT NOTES REGARDING APPLICATION OF “NUDURA FRIENDLY” DIMENSIONS

Though a designer may use this information to ensure the most optimal design for NUDURA form units possible, there are factors to be considered in the planning and final installation of the product in-field:

Not every designated wall of a NUDURA plan layout can be designed to be optimally laid out to “NUDURA Friendly” dimensions. This is definitely true for building layouts where there are odd numbers of outside or inside corners. In such cases, ONE of the intersecting dimensions to the odd corner MUST be sacrificed to meet the optimal layout condition. The non-conforming plan dimension can simply be indicated on the plan to alert the in-field contractor that one of the walls intersecting this corner will have to be custom built with a smaller than 8”(203 mm) increment.

In the perfect world of computer aided design, dimensional layouts are always exact. Despite the intent of achieving perfect NUDURA dimensioning, the designer and contractor should bear in mind that ICF products being formed with EPS foam are subject to minor product dimensional tolerances that must be taken care of in the final in-field build. While NUDURA quality control processes strive to achieve tolerances within +/- 1/8” (3.2 mm), form unit length tolerances can vary by as much as 1/8” (3.2 mm) shorter or up to 3/8” (9.5 mm) longer on an 8' (2.44 m) standard form as a result of variances in, EPS bead type, EPS pre-expansion levels, bead aging time, manufacturing plant humidity and temperature at time of molding, and rate of post-mould shrinkage. Generally the product is rarely on the high or low end of these tolerances. NUDURA’s manufacturing facilities take great pride in ensuring that all products produced maintain a constant dimension. However, both designer and contractor/installer must be ever mindful that accommodation of this factor may, at some point in time, have to be made in the final installation.

T FORM UNIT SCENARIOS

There are 16 possible combinations of T Form Units in concert with all available corner conditions, meaning that across all 5 core thicknesses of forms, the possible table combinations of available corner configurations when combining forms of different or same core thicknesses are simply too numerous to present in pre-calculated dimension, tabular format. In lieu of pre-calculated dimension tables, NUDURA has compiled each of these 16 scenarios into basic base dimension reference tables that cover each possible corner configuration combination and enable the user to easily calculate the closest “NUDURA friendly” dimension needed for the projects design.

In the pages following, NUDURA has elected to show 2 sample calculations to give an idea of how to work with the tables to arrive at the required “NUDURA Friendly” dimension (one sample shown in imperial dimension, the other shown in metric, covering 2 different long and short T combinations). As with the corner to corner scenarios, each of the 16 T Form calculation scenarios can be found in the NUDURA Friendly Dimension Table document.

Example FORM UNIT LAYOUT CHARTS

Corner to Corner Layout Charts	
Step 1: Locate Chart that coincides with your core thickness and corner condition.	
Step 2: Find dimension closest to that which you desire for the corner condition.	
Step 3: Closest dimensions to 20' (6100 mm) are 19' 10 5/8" (6057 mm) or 20' 6 5/8" (6260 mm), so for example take 19' 10 5/8" as the overall wall length.	
Step 4: Subtract initial length of two corner forms (first unshaded cell) from Dimension A. Eg 19' 10 5/8" - 3' 2 5/8" = 16' 8"	
Step 5: Calculate number of standards between. Balance is 16' 8" or (5080 mm), so divided by 8' (2438 mm) to give, 2 standard blocks and one 8" (200 mm) piece of standard block.	

8" (200 mm) 90° to 45° Corner Form Units			
Dim. A (Imp)	Dim. A (Met. mm)	Dim. A (Imp)	Dim. A (Met. mm)
1' 10 5/8"	576		
2' 6 5/8"	779		
3' 2 5/8"	982	27' 2 5/8"	8290
3' 10 5/8"	1185	27' 10 5/8"	10293
4' 6 5/8"	1388	28' 6 5/8"	12296
5' 2 5/8"	1591	29' 2 5/8"	14299
5' 10 5/8"	1794	29' 10 5/8"	16302
6' 6 5/8"	1997	30' 6 5/8"	18305
7' 2 5/8"	2200	31' 2 5/8"	20308
7' 10 5/8"	2403	31' 10 5/8"	22311
8' 6 5/8"	2606	32' 6 5/8"	24314
9' 2 5/8"	2809	33' 2 5/8"	26317
9' 10 5/8"	3012	33' 10 5/8"	28320
10' 6 5/8"	3215	34' 6 5/8"	30323
11' 2 5/8"	3418	35' 2 5/8"	32326
11' 10 5/8"	3621	35' 10 5/8"	34329
12' 6 5/8"	3824	36' 6 5/8"	36332
13' 2 5/8"	4027	37' 2 5/8"	38335
13' 10 5/8"	4230	37' 10 5/8"	40338
14' 6 5/8"	4433	38' 6 5/8"	42341
15' 2 5/8"	4636	39' 2 5/8"	44344
15' 10 5/8"	4839	39' 10 5/8"	46347
16' 6 5/8"	5042	40' 6 5/8"	48350
17' 2 5/8"	5245	41' 2 5/8"	50353
17' 10 5/8"	5448	41' 10 5/8"	52356
18' 6 5/8"	5651	42' 6 5/8"	54359
19' 2 5/8"	5854	43' 2 5/8"	56362
19' 10 5/8"	6057	43' 10 5/8"	58365
20' 6 5/8"	6260	44' 6 5/8"	60368
21' 2 5/8"	6463	45' 2 5/8"	62371
21' 10 5/8"	6666	45' 10 5/8"	64374
22' 6 5/8"	6869	46' 6 5/8"	66377
23' 2 5/8"	7072	47' 2 5/8"	68380
23' 10 5/8"	7275	47' 10 5/8"	70383
24' 6 5/8"	7478	48' 6 5/8"	72386
25' 2 5/8"	7681	49' 2 5/8"	74389
25' 10 5/8"	7884	49' 10 5/8"	76392
26' 6 5/8"	8087	50' 6 5/8"	78395

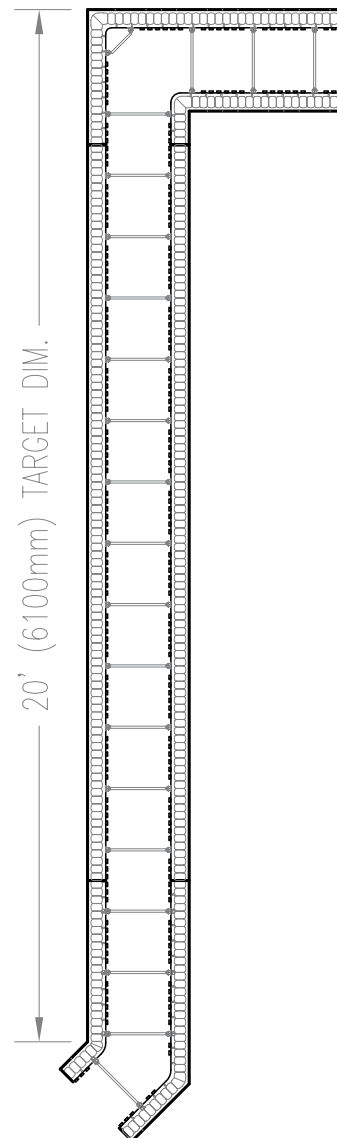
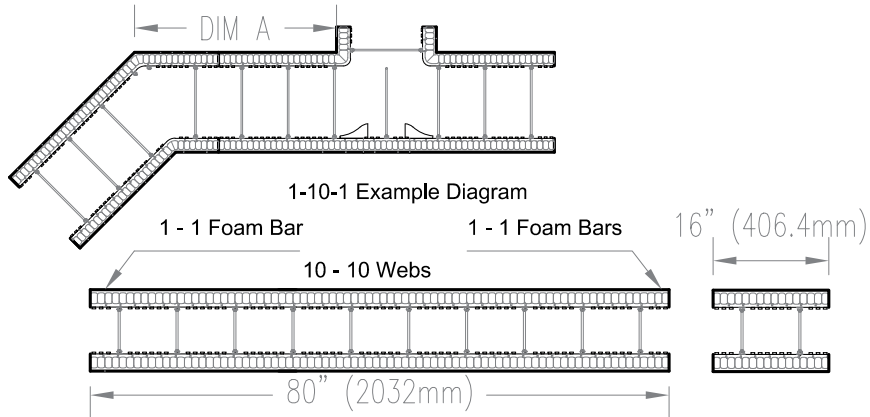

FIGURE 2.12

T FORM UNIT LAYOUT CHARTS Example Sheet



T Form Core Thickness		Main Wall Core Thickness				
		4" (102mm)	6" (152mm)	8" (203mm)	10" (254mm)	12" (305mm)
4" (102mm)	Dim A (Imp)	30.875"	30.875"	30.875"	32.875"	34.875"
	Dim A (Met)	785	785	785	838	887
6" (152mm)	Dim A (Imp)	30.875"	30.875"	30.875"	32.875"	34.875"
	Dim A (Met)	785	785	785	838	887
8" (203mm)	Dim A (Imp)	30.875"	30.875"	30.875"	32.875"	34.875"
	Dim A (Met)	785	785	785	838	887
10" (254mm)	Dim A (Imp)	30.875"	30.875"	30.875"	32.875"	34.875"
	Dim A (Met)	785	785	785	838	887
12" (305mm)	Dim A (Imp)	30.875"	30.875"	30.875"	32.875"	34.875"
	Dim A (Met)	785	785	785	838	887

Because of the modular dimensions of the MUDURA form units, we can calculate dimensions for plans to make installation as easy as possible. To learn how to calculate these dimensions, see the example below. (For Metric calculations see Figure 2.14)

Find Wall Thickness, and corresponding table. For this example we will use the Short T to Short 45° in a 4" core thickness.

Step 1: Desired dimension from inside of T to outside of 45° is 17' 8"

Convert to inches: $17 \times 12 + 8 = 208$ in

Step 2: Subtract Dimension A from Chart from Desired Dimension

$208 - 30.875 = 177.125$ in

Step 3: Find the number of T increments by dividing the desired offset by 8

$177.125 / 8 = 22.14$

Step 4: At this point you decide to round up or down. Rounding down will make the desired dimension shorter, as rounding up will make it longer. For the case of the example, we will round down to 22 increments. Divide this number by 12 to find the amount

$22 / 12 = 1.833$ (round up to 1 Standard and a 1-10-1 Core Diagram) (180 + 96 = 276 in)

Two joints

(Center unit + T Form Unit) + 1 Standard and a 1-10-1 Standard-Cut Form

$(36.875) + 96 = 96 + 36.875 = 133.875$ in

Therefore, by rounding down the overall dimension of the wall should be 17' 8 1/2"

FIGURE 2.13

T FORM UNIT LAYOUT CHARTS Example Sheet

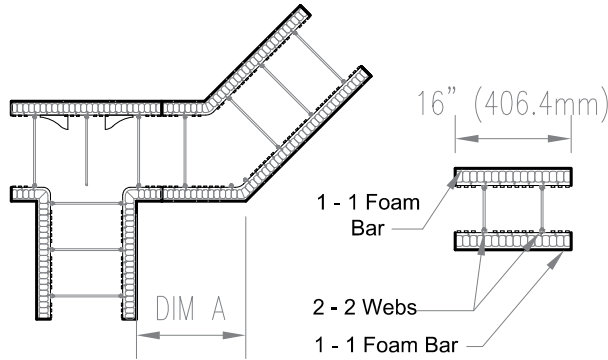

Decimal Conversion Table	
.125	= 1/8"
.250	= 1/4"
.375	= 3/8"
.500	= 1/2"
.625	= 5/8"
.750	= 3/4"
.875	= 7/8"

T Form Core Thickness		Main Wall Core Thickness				
		4" (102mm)	6" (152mm)	8" (203mm)	10" (254mm)	12" (305mm)
4" (102mm)	Dim A (Imp)	14.875"	14.875"	14.875"	16.875"	18.875"
	Dim A (Met)	378	378	378	429	479
6" (152mm)	Dim A (Imp)	14.875"	14.875"	14.875"	16.875"	18.875"
	Dim A (Met)	378	378	378	429	479
8" (203mm)	Dim A (Imp)	14.875"	14.875"	14.875"	16.875"	18.875"
	Dim A (Met)	378	378	378	429	479
10" (254mm)	Dim A (Imp)	14.875"	14.875"	14.875"	16.875"	18.875"
	Dim A (Met)	378	378	378	429	479
12" (305mm)	Dim A (Imp)	14.875"	14.875"	14.875"	16.875"	18.875"
	Dim A (Met)	378	378	378	429	479

Because of the fractional dimensions of the TUDURA form brick, we can calculate dimensions for joints to make installation as easy as possible. To learn how to calculate these dimensions, see the example below. (For Imperial calculations see Figure 2.13.)

Final Wall Thickness, and corresponding joints. For this example we will use the Long T to Short 45° in a 203mm core thickness.

Step 1: Desired dimension from inside of T to outside of 45° is 224mm

No adjustment required

Step 2: Subtract Dimension A from Chart from Desired Dimension

$224 - 429 = 277$

Step 3: Find the number of 203mm increments by dividing the balance above by 203

$277 \div 203 = 1.36$

Step 4: At the joint you decide to round up or down. Rounding down will make the desired dimension shorter, so rounding up will make it longer. For the sake of the example, we will round up to 14 increments. Divide this number by 12 to find the amount of

$14 \div 12 = 1.167$ Forms or 1 Standard and a 1/2-T (see Figure 2.13) $(107 + 3426.4 = 407.3mm)$

The yield:

(Cover joint + T Form Unit) = 1 Standard and a 1/2-T Standard and a 3/16-T Standard Td Form

$407.3 + 3426.4 + 407.3 = 3241.0mm$

Therefore, by rounding up the overall dimension of the wall should be 3241mm

FIGURE 2.14

RADIUS WALL SCENARIOS

Radius walls are formed simply through the use of NUDURA's straight 8' (2.44 m) standard form unit panel system coupled with NUDURA's cross linked insert webs. The contractor/installer does not need to worry about perfect configuration of "NUDURA Friendly" dimensions for radius wall designs since coordination of in-field construction is largely handled through the custom radius cuts that are made at the factory. NUDURA Inc. has developed a simple Radius Wall Calculation Spread Sheet which assists the contractor/installer and designer in knowing what lengths of form cuts will be made by the computer program at our plant to facilitate the cutting of the segments to construct a radius wall. Should the contractor/installer require a copy of the electronic version for in-field cutting of a radius wall, please contact the local distributor. For more information on radius walls, refer to the Technical Bulletin on this subject, included in Appendix F.

2.1.5 WALL HEIGHT CHARTS

Stack heights for ensuring wall heights are achieved with NUDURA construction can be particularly important especially when considering such things as:

- Footing elevations relative to grade
- Brick finishes relative to grade levels
- Floor bearing heights relative to finished grade
- Floor bearing height relative to each other

NUDURA's form heights do not always need to be considered for elevation design layout. Contractor/installers working regularly with the NUDURA Wall System will plan stack heights to suit the elevation layout requirements of the building as assigned by the architect or designer, no matter what this may be. However, if the designer requires optimum conditions for ease of construction of NUDURA on site, here is a list of tips to remember for achieving optimum design for installation of NUDURA forms:

- Avoid using height adjusters or use them sparingly. Using height adjusters will add to the labor cost due to the fact that they are 32" (813 mm) in length by 3" (76 mm) high. The man-hours/ft² (man-hours/m²) will increase significantly for this area of the wall. Therefore, if floor heights can be coordinated with the design to avoid use of height adjusters, this will serve to make the project more cost efficient.
- If a half form will achieve optimum stack height within the projected wall assembly from top of footing to parapet or roof line, plan to use the half height form at either the footing or the top of the wall or roof line. Do NOT specify half height forms at any portion of a continuous stack height as this will cause additional form support to have to be added by the installer prior to concrete placement.
- When installing brick ledges, it is recommended to adjust the height of the first course in order to ensure that the brick line starts at a full course. If this is not possible then the brick elevation can be achieved by using the NUDURA Brick Ledge Extension Form.
- When planning complex details, always remember that if full height hinge pin web forms are being used, the crucial structural hinge pin ties that connect the panels together start at 2" (50 mm) from the top and bottom of the form and are each 3" (76 mm) in height. Avoid any detailing that will require the installer to cut the form in this region. If this is unavoidable, be sure to detail it as an insert web form and the installer will order and install accordingly, and will detail the web connections to handle the condition of bearing accordingly.
- Avoid using Brick Ledge Forms as floor supports for any application. Brick Ledge Forms have limited bearing capacities and therefore should not be relied on for carrying floor loads. Additional finishing requirements of the corbel could prove undesirable to the building owner.

GETTING STARTED

The following are optimal stack height charts for planning wall stack heights up to 36' 6" (11.125 m) in height. Obviously, higher wall heights are possible and employ the same basics of geometry as illustrated on the following pages.

IMPERIAL OR U.S. STANDARD DIMENSION WALL HEIGHT CHART

NO. OF COURSES	STANDARD FORM HEIGHT OF WALL (FT/IN)	PLUS ONE 3" HIGH HEIGHT ADJUSTER (FT/IN)	PLUS ONE 6" HIGH HALF OPTIMIZER (OR CUT STANDARD) (FT/IN)	PLUS ONE 9" HIGH HALF STANDARD (FT/IN)	PLUS ONE 12" HIGH OPTIMIZER FORM (FT/IN)	PLUS ONE 15" HIGH SEGMENT (FT/IN)
1	1' 6"	1' 9"	2'	2' 3"	2' 6"	2' 9"
2	3'	3' 3"	3' 6"	3' 9"	4'	4' 3"
3	4' 6"	4' 9"	5'	5' 3"	5' 6"	5' 9"
4	6'	6' 3"	6' 6"	6' 9"	7'	7' 3"
5	7' 6"	7' 9"	8'	8' 3"	8' 6"	8' 9"
6	9'	9' 3"	9' 6"	9' 9"	10'	10' 3"
7	10' 6"	10' 9"	11'	11' 3"	11' 6"	11' 9"
8	12'	12' 3"	12' 6"	12' 9"	13'	13' 3"
9	13' 6"	13' 9"	14'	14' 3"	14' 6"	14' 9"
10	15'	15' 3"	15' 6"	15' 9"	16'	16' 3"
11	16' 6"	16' 9"	17'	17' 3"	17' 6"	17' 9"
12	18'	18' 3"	18' 6"	18' 9"	19'	19' 3"
13	19' 6"	19' 9"	20'	20' 3"	20' 6"	20' 9"
14	21'	21' 3"	21' 6"	21' 9"	22'	22' 3"
15	22' 6"	22' 9"	23'	23' 3"	23' 6"	23' 9"
16	24'	24' 3"	24' 6"	24' 9"	25'	25' 3"
17	25' 6"	25' 9"	26'	26' 3"	26' 6"	26' 9"
18	27'	27' 3"	27' 6"	27' 9"	28'	28' 3"
19	28' 6"	28' 9"	29'	29' 3"	29' 6"	29' 9"
20	30'	30' 3"	30' 6"	30' 9"	31'	31' 3"
21	31' 6"	31' 9"	32'	32' 3"	32' 6"	32' 9"
22	33'	33' 3"	33' 6"	33' 9"	34'	34' 3"
23	34' 6"	34' 9"	35'	35' 3"	35' 6"	35' 9"
24	36'	36' 3"	36' 6"	36' 9"	37'	37' 3"

Note: The 15" segment can be achieved by cutting a Standard Form or using one Optimizer Form and one Height Adjuster

FIGURE 2.15

METRIC DIMENSION WALL HEIGHT CHART

NO. OF COURSES	STANDARD FORM HEIGHT OF WALL (METERS)	PLUS ONE 7.2 mm HIGH HEIGHT ADJUSTER (METERS)	PLUS ONE 152 mm HIGH HALF OPTIMIZER (OR CUT STANDARD) (METERS)	PLUS ONE 229 mm HIGH HALF STANDARD (METERS)	PLUS ONE 305 mm HIGH OPTIMIZER FORM (METERS)	PLUS ONE 381 mm HIGH SEGMENT (METERS)
1	0.457	0.533	0.610	0.686	0.762	0.838
2	0.914	0.991	1.067	1.143	1.219	1.295
3	1.372	1.448	1.524	1.600	1.676	1.753
4	1.829	1.905	1.981	2.057	2.133	2.210
5	2.286	2.363	2.438	2.514	2.590	2.668
6	2.743	2.820	2.895	2.971	3.047	3.125
7	3.201	3.277	3.352	3.428	3.504	3.582
8	3.658	3.734	3.809	3.885	3.961	4.040
9	4.116	4.192	4.266	4.342	4.418	4.497
10	4.573	4.649	4.723	4.799	4.875	4.955
11	5.030	5.106	5.180	5.256	5.332	5.412
12	5.488	5.564	5.637	5.713	5.789	5.869
13	5.945	6.021	6.094	6.170	6.246	6.327
14	6.403	6.478	6.551	6.627	6.703	6.784
15	6.861	6.936	7.008	7.084	7.160	7.242
16	7.317	7.393	7.465	7.541	7.617	7.699
17	7.775	7.850	7.922	7.998	8.074	8.156
18	8.232	8.307	8.379	8.455	8.531	8.614
19	8.690	8.765	8.836	8.912	8.988	9.071
20	9.147	9.222	9.293	9.369	9.445	9.529
21	9.604	9.679	9.750	9.826	9.902	9.986
22	10.062	10.137	10.207	10.283	10.359	10.443
23	10.519	10.594	10.664	10.740	10.816	10.901
24	10.977	11.051	11.121	11.197	11.273	11.358

Note: The 381mm segment can be achieved by cutting a Standard Form or using one Optimizer Form and one Height Adjuster

FIGURE 2.16

2.2 ESTIMATING

2.2.1 IMPERIAL (US STANDARD) FORMULAE

NUDURA material requirements for any project can easily be determined manually through the simple calculations within this manual. In all cases the estimator must collect the following information from the plan in order to ensure the estimate is accurate.

Please refer to Section 2.2.2 for Metric Calculation Formulae.

Total linear footage of perimeter _____

Total # of 90° corners _____

Total # of 45° corners _____

Total # of T connections _____

Total linear footage of tapered top form _____

Total linear footage of brick ledge form _____

Total linear footage of brick ledge extension _____

Height of the wall _____

Total # of courses _____

Total linear footage of optimizer _____

Total linear footage of height adjusters _____

Total # of courses of height adjusters _____

Total linear footage to be waterproofed _____

Total height to be waterproofed _____

Total linear footage to be parged _____

Total height to be parged _____

Total ft² of openings (width x height) _____

Total linear footage of opening width _____

Total linear footage of opening height _____

Wall cavity thickness _____

The estimator will need to take the total linear footage of the building and add 2 ft for each inside 90° corner and 1 ft for each inside 45° corner on the footprint.

This chart enables an estimator working in imperial or US Standard dimensions to easily summarize the necessary information regarding total opening width and height for estimating rough buck material along with the total ft² of openings there are in the building. These totals will be used in estimating formulas further on in this section.

IMPERIAL OR US STANDARD DIMENSION OPENINGS SUMMARY CHART				
OPENING #	QUANTITY	X WIDTH	X HEIGHT	= TOTAL FT ²
TOTALS				

TO CALCULATE THE STANDARD FORM UNITS:

- Gross Wall Area (ft²) = Total Linear footage of wall (ft) x Total Height (ft)
- Net Wall Area (ft²) = Gross Wall Area (ft²) – Total area of openings (ft²)
- Total Standards/course = (Total Linear footage of wall – (# 90° Corners x 4) – (# 45° Corners x 3)) ÷ 8
- Total Standards before deductions = Total Standards/course x # of courses

If brick ledge, taper top, or T forms are needed for the building they need to be subtracted off the total standards calculated above.

- Standards (BL) = Lineal Footage of Brick Ledge ÷ 8
- Standards (TT) = Lineal Footage of Taper Top ÷ 8
- Standards (OP) = ((LFOP x # COP) ÷ 4) ÷ 3
- Standards (TF) = (# of T Forms x # of courses) ÷ 2
- Total Standards = Total Standards before deductions - Standards (BL) - Standards (TT) - Standards (OP) - Standards (TF)

TO CALCULATE THE NUMBER OF 90° CORNER FORMS:

$$90^\circ \text{ form} = \#90 \times \#C$$

This formula multiplies the number of 90° turn by the number of courses.

TO CALCULATE THE NUMBER OF 45° CORNER FORMS:

$$45^\circ \text{ form} = \#45 \times \#C$$

This formula multiplies the number of 45° turn by the number of courses.

TO CALCULATE THE NUMBER OF T FORMS:

$$T \text{ form} = \#Ts \times \#C$$

This formula multiplies the T connection by the number of courses.

TO CALCULATE THE NUMBER OF BRICK LEDGE FORMS:

$$BLF4 = LFBLF \div 4 \text{ or } BLF8 = LFBLF \div 8$$

This formula divides the linear footage of brick ledge form units by 4 or 8. Brick Ledge forms are available in 2 lengths. 8' lengths are available from NUDURA's Canadian plant and the 4' length is available from the US plant.

Note: Additional brick ledge form units may be required for corners.

TO CALCULATE THE NUMBER OF BRICK LEDGE EXTENSIONS:

$$\begin{aligned} BLE &= LFBLE \times .375 \\ \# \text{ of Screws} &= BLE \times 3 \\ \# \text{ of V Strips} &= BLE \div 3 \end{aligned}$$

This formula multiplies the linear footage of brick ledge extension by .375. The formulas also calculate the number of screws needed for attaching the BLE and also the V Strips needed also.

Note: Additional brick ledge extension may be required for corners.

TO CALCULATE THE NUMBER OF OPTIMIZER FORMS:

$$\begin{aligned} OP &= (LFOP \times \# COP) \div 4 \\ OP \text{ Ties} &= OP \times 6 \end{aligned}$$

This formula corrects the linear footage of perimeter of Optimizer required, divides by 4, multiplies by 2 and multiplies by the number of courses required.

TO CALCULATE THE NUMBER OF HEIGHT ADJUSTERS:

$$\begin{aligned} HA &= (LFHA \times 2 \times \#CHA) \div 2.67 \\ HA \text{ Ties} &= (HA \div 2) \times 4 \end{aligned}$$

This formula corrects the linear footage of perimeter of Height Adjuster required, divides by 2.67', multiplies by 2 and multiplies by the number of courses required.

TO CALCULATE THE NUMBER OF ROLLS OF WATERPROOFING:

$$WP = LFWP \times HWP \div 210$$

A roll of waterproofing is 225 sq. ft. but the effective coverage is 210 sq. ft. allowing for overlapping the edge of the membrane.

TO CALCULATE THE NUMBER OF BAGS OF PRECOAT PARGING MIX:

$$PC = LFPAR \times HPAR \div 75$$

The surface area to be parged is divided by 75 which is the average coverage obtained per bag for two coat application.

TO CALCULATE THE NUMBER FIBER MESH ROLLS:

$$FM = LFPAR \times HPAR \div 475$$

A roll of fiber mesh is 475 sq. ft. an allowance for overlap may be required depending on the application techniques.

TO CALCULATE THE QUANTITY OF WALL ALIGNMENT SYSTEM:

$$WAS = LFPER + 1 \text{ per corners or tees} \div 5.333$$

The formula allows for one unit every 5' 4" plus an additional unit for every corner and tee wall connection. Should a site have numerous openings with center of opening less than 5' 4" apart the quantity of WAS may need to be increased.

TO CALCULATE THE AMOUNT OF REBAR:

How to Determine the Required Reinforcing Steel to Wall Area "Ratio"

The ratios shown in Table 2.2.1.1 (below) have been calculated by totaling the bar length specified for each scenario then dividing this length by the total square footage of wall area that encompasses these bars. Using this method, a ratio can be specified for both vertical and horizontal mats of steel separately (if they are different diameters from each other) Or if both mats are the same diameter of steel, the ratio can be specified as a "Combined Steel Mat".

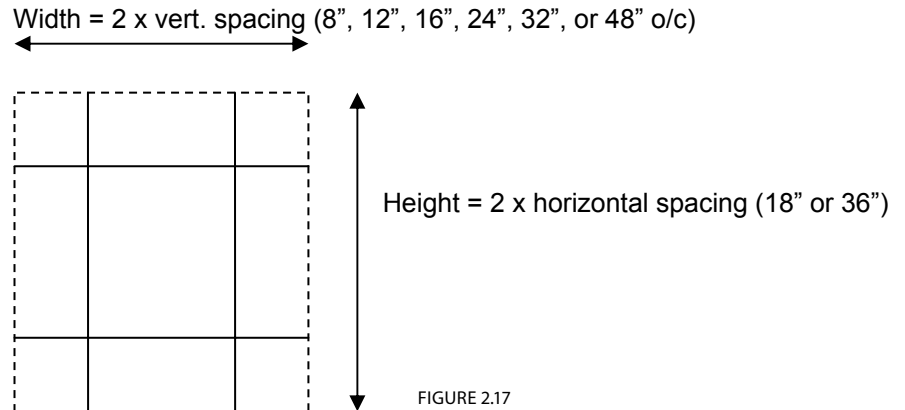

REBAR = LPPER X HW X
Multiplier (see Table 2.2.1.1)

The linear footage of the wall is multiplied by the height of the wall and multiplied by a value obtained in Table 1.0 which is a constant. The result is in feet. This constant is for a rebar grid in the wall 18" x 16" horizontally and vertically respectively with an allowance for horizontal splices.

Table 2.2.1.1

	Vert. o/c Spacing (in.)	Horiz. o/c Spacing (in.)	Ratio LF/SF of Wall Single Mat	Ratio LF/SF of Wall Double Mat
Vertical Only Steel Mat	8"	-	1.500	3.000
	16"	-	0.750	1.500
	24"	-	0.500	1.000
	32"	-	0.375	0.750
	48"	-	0.250	0.500
Horizontal Only Steel Mat	-	18"	0.750	1.500
	-	36"	0.375	0.750
Combined Steel Mat	8"	18"	2.250	4.500
	8"	36"	1.875	3.750
	16"	18"	1.500	3.000
	16"	36"	1.125	2.250
	24"	18"	1.250	2.500
	24"	36"	0.875	1.750
	32"	18"	1.125	2.250
	32"	36"	0.750	1.500
	48"	18"	1.000	2.000
48"	36"	0.625	1.250	

GETTING STARTED

TO CALCULATE THE VOLUME OF CONCRETE:

$$\text{Yds}^3 \text{ of concrete} = \text{LPPER} \times \text{HW} \times \text{MULTIPLIER (Table 2.2.1.1)}$$

The concrete multipliers shown in Table 2.2.1.2 (below) are constants, each of which represents the total volume of concrete (in cubic yards) that is necessary to cover 1 square foot of wall area for the specified core thickness of form. To calculate the amount of concrete required to fill the wall, simply multiply the total area of the wall (in square feet) by the multiplier shown for the selected core thickness of form. The volume of concrete ordered should be reduced in accordance with window and door openings. If using a concrete pump as a method of placement, an allowance must be included within the calculated volume of concrete to account for waste. NUDURA recommends an additional concrete volume of 1 yd³ to 2 yd³ for the pump unit.

TABLE 2.2.1.2

Concrete Core Size	Concrete Multiplier
4.25"	0.013
6.25"	0.019
8.25"	0.026
10.25"	0.032
12.25"	0.038

TO CALCULATE THE NUMBER OF VERTICAL JOINT CLIPS:

$$\text{VJC} = (\text{LPPER} \div 8' \times 4 \text{ per standard} \times \# \text{ of courses}) + (\# \text{ of Corners} \times 4 \times \# \text{ of courses})$$

The VJC formula takes the lineal footage of the perimeter of the structure and divides by the length of a standard form. Then multiply this by 4 per standard form and then multiply again by the number of courses. The second part of this formula then takes the number of corners and multiplies by 4 clips per corner and then multiplies by the number of courses.

Note: Remember that what is in the brackets must be completed before adding them together for the total number of clips.

ESTIMATING FORMULAE SUMMARY – (IMPERIAL/ US STANDARD)**STANDARD FORM UNITS:**

Gross Wall Area (ft²) = Total Linear footage of wall (ft) x Total Height (ft)

Net Wall Area (ft²) = Gross Wall Area (ft²) – Total area of openings (ft²)

Total Standards/course = (Total Lineal footage of wall – (# 90° Corners x 4) – (# 45° Corners x 3)) ÷ 8

Total Standards before deductions = Total Standards/course x # of courses

Standards (BL) = Lineal Footage of Brick Ledge ÷ 8

Standards (TT) = Lineal Footage of Taper Top ÷ 8

Standards (OP) = ((LFOP x # COP) ÷ 4) ÷ 3

Standards (TF) = (# of T Forms x # of courses) ÷ 2

TOTAL STANDARDS = Total Stds before deductions - Stds (BL) – Stds (TT) - Stds (OP) - Stds (TF)

90° FORM UNIT: 90° FORM = #90 x #C

45° FORM UNIT: 45° FORM = #45 x #C

T FORM UNIT: T FORM = #Ts x #C

BRICK LEDGE FORM 4' UNIT: BLF4 = LFBLF ÷ 4

BRICK LEDGE FORM 8' UNIT: BLF8 = LFBLF ÷ 8

OPTIMIZER FORM UNIT: OP = (LFOP x # COP) ÷ 4

OP Ties = OP x 6

BRICK LEDGE EXTENSION: BLE = LFBLE x 0.375

of Screws = BLE x 6

HEIGHT ADJUSTER: HA = (LFHA x 2 x #CHA) ÷ 2.67

HA Ties = (HA ÷ 2) x 4

WATERPROOFING: WP = LFWP x HWP ÷ 210

PARGING COAT: PC = LFPAR x HPAR ÷ 75

FIBER MESH: FM = LFPAR x HPAR ÷ 475

WALL ALIGNMENT SYSTEMS: WAS = (LFPER + 1 per corner or tees) ÷ 5.33

REBAR: REBAR = LFPER x HW x 1.5

CONCRETE (IMPERIAL) Yds³ = LFPER x HW x Concrete Multiplier (Table 2.2.1.2)

VERTICAL JOINT CLIPS VJC = (LFPER ÷ 8' x 4 per standard x # of courses) + (# of Corners x 4 x # of courses)

GETTING STARTED

ESTIMATING RADIUS WALLS (IMPERIAL OR US STANDARD)

For determining total number of radius forms required for on site construction of a NUDURA radius wall or for preparing an order for factory cut NUDURA radius forms, you can use the calculation formula below. This formula assumes that any radius constructed will be an “arc length segment” of a full circle with a known angle of rotation:

The following information is required to determine total number of radius forms for any given radius wall in a floor plan:

1. The Outside radius (measured in inches from the focus point to the outside face of the NUDURA form)
2. The Inside Radius (equals the Outside Radius in inches less the total form thickness being used)
3. The Degrees of Turn of Radius (this is total number of degrees of rotation that the radius covers of a full circle)
4. The Total Wall Height (measured in inches).

TO CALCULATE THE TOTAL NUMBER OF RADIUS FORMS REQUIRED:

No. of forms per course		No. of courses
No. of Forms = Outside Radius (in inches) x 6.283 x (Degrees of Turn of Radius/360)	X	Wall Height (in inches)
<hr/> 96		<hr/> 18

NOTES:

1. To assure adequate product for accommodating custom fitting of the wall forms into the standard elements of the plan, the first part of the calculation (no. of forms per course) above should be **ROUNDED** up to a whole number or (full form length) before multiplying by the number of courses of forms required.
2. Do **NOT** deduct any allowance for openings particularly if placing orders at the factory for custom radius forms.

As an alternate, you can also obtain NUDURA’s radius wall form unit spread sheet calculator through your distributor which enables the same calculation to be performed in Microsoft excel® along with giving the required cut segment lengths. (The distributor can also duplicate the quantity portion of this calculator by entering data into the NUDURA radius wall digital order form).

Further guidance on estimating for NUDURA radius walls is available through your NUDURA distributor OR can be downloaded directly from the Construction Professional Section of NUDURA’s Website under “Technical Bulletins and Guides”.

2.2.2 METRIC FORMULAE

NUDURA material requirements for any project can easily be determined manually through the simple calculations within this manual. In all cases the estimator must collect the following information from the plan in order to ensure the estimate is accurate.

Please refer to section 2.2.1 for the imperial formulas.

Total linear meters of perimeter _____

Total # of 90° corners _____

Total # of 45° corners _____

Total # of T connections _____

Total linear meters of tapered top form _____

Total linear meters of brick ledge form _____

Total linear meters of brick ledge extension _____

Height of the wall _____

Total # of courses _____

Total linear meters of height adjusters _____

Total linear meters of optimizer _____

Total # of courses of height adjusters _____

Total linear meters to be waterproofed _____

Total height to be waterproofed _____

Total linear meters to be parged _____

Total height to be parged _____

Total m² of openings (width x height) _____

Total linear meters of opening width _____

Total linear meters of opening height _____

Wall cavity thickness _____

The estimator will need to take the total lineal footage of the building and add 0.61 m for each inside 90° corner and 0.31 m for each inside 45° corner on the footprint.

GETTING STARTED

This chart enables an estimator working in metric dimensions to easily summarize the necessary information regarding total opening width and height for estimating rough buck material along with the total m² of openings there are in the building. These totals will be used in estimating formulas further on in this section.

METRIC DIMENSION OPENINGS SUMMARY CHART				
OPENING #	QUANTITY	X WIDTH	X HEIGHT	= TOTAL m ²
TOTALS				

TO CALCULATE THE STANDARD FORM UNITS:

- Gross Wall Area (m²) = Total Linear footage of wall (m) x Total Height (m)
- Net Wall Area (m²) = Gross Wall Area (m²) – Total area of openings (m²)
- Total Standards/course = (Total Lineal meters of wall – (# 90° Corners x 4) – (# 45° Corners x 3)) ÷ 2.44
- Total Standards before deductions = Total Standards/course x # of courses

If brick ledge, taper top, or T forms are needed for the building they need to be subtracted off the total standards calculated above.

- Standards (BL) = Lineal meters of Brick Ledge ÷ 2.44
- Standards (TT) = Lineal meters of Taper Top ÷ 2.44
- Standards (OP) = ((LMOP x # COP) ÷ 1.219) ÷ 3
- Standards (TF) = (# of T Forms x # of courses) ÷ 0.61
- Total Standards = Total Standards before deductions - Standards (BL) - Standards (TT) - Standards (TF)

TO CALCULATE THE NUMBER OF 90° CORNER FORMS:

$$90^\circ \text{ form} = \#90 \times \#C$$

This formula multiplies the number of 90° corners by the number of courses.

TO CALCULATE THE NUMBER OF 45° CORNER FORMS:

$$45^\circ \text{ form} = \#45 \times \#C$$

This formula multiplies the number of 45° angles by the number of courses.

TO CALCULATE THE NUMBER OF T FORMS:

$$T \text{ form} = \#T \times \#C$$

This formula multiplies the T connection by the number of courses.

TO CALCULATE THE NUMBER OF BRICK LEDGE FORMS:

$$BLF = LDBLF \div 2.44 \text{ or } BLF8 = LDBLF \div 1.22$$

This formula divides the linear footage of brick ledge form units by 1.22 or 2.44. Brick Ledge forms are available in 2 lengths; 2.44m lengths are available from NUDURA's Canadian plant and the 1.22m lengths are available from the US plant. Note: Additional brick ledge form units may be required for corners.

TO CALCULATE THE NUMBER OF BRICK LEDGE EXTENSIONS:

$$\begin{aligned} BLE &= LDBLE \div 0.8128 \\ \# \text{ of Screws} &= BLE \times 6 \end{aligned}$$

This formula divides the linear meters of brick ledge extension by 0.8128. Note: Additional brick ledge extension may be required for corners.

TO CALCULATE THE NUMBER OF OPTIMIZER FORMS:

$$\begin{aligned} OP &= (LMOP \times 2 \times \#COP) \div 1.219 \\ OPTIES &= (OP \div 2) \times 6 \end{aligned}$$

This formula corrects the linear meters of perimeter of Optimizer required, divides by 4, multiplies by 2 and multiplies by the number of courses required.

TO CALCULATE THE NUMBER OF HEIGHT ADJUSTERS:

$$\begin{aligned} HA &= (LDHA \times \#CHA \times 2) \div 0.8128 \\ HA \text{ Ties} &= (HA \div 2) \times 4 \end{aligned}$$

This formula divides the length of Height Adjuster (0.8128 m), and multiplies by the number of courses required

TO CALCULATE THE NUMBER OF ROLLS OF WATERPROOFING:

$$WP = LMWP \times HWP \div 19.5$$

A roll of waterproofing is 20.9 sq. m. but the wall coverage is 19.5 m². This allows for a 76 mm overlap at the edges of the membrane.

TO CALCULATE THE NUMBER OF BAGS OF PRECOAT PARGING MIX:

$$PC = LMPAR \times HPAR \div 6.97$$

The surface area to be parged is divided by 6.97 m². This is the average coverage obtained per bag for a two coat application. (Base & Finish Coats)

TO CALCULATE THE NUMBER OF FIBER MESH ROLLS:

$$FM = LMPAR \times HPAR \div 44.1$$

A roll of fiber mesh is 44.1 sq. m. An allowance for overlap may be required depending on the application techniques.

TO CALCULATE THE QUANTITY OF WALL ALIGNMENT SYSTEM:

$$WAS = LDPER + 1 \text{ per corner and T intersections} \div 1.63$$

The formula allows for one unit every 1.63 m plus an additional unit for every corner and T wall connection. Should a site have numerous openings with center of opening less than 1.63 m apart, the quantity of WAS may need to be increased.

GETTING STARTED

TO CALCULATE THE AMOUNT OF REBAR:

How to Determine the Required Reinforcing Steel to Wall Area "Ratio"

The ratios shown in Table 2.2.2.1 have been calculated by totaling the bar length specified for each scenario then dividing this length by the total square footage of wall area that encompasses these bars. Using this method, a ratio can be specified for both vertical and horizontal mats of steel separately (if they are different diameters from each other) Or if both mats are the same diameter of steel, the ratio can be specified as a "Combined Steel Mat".

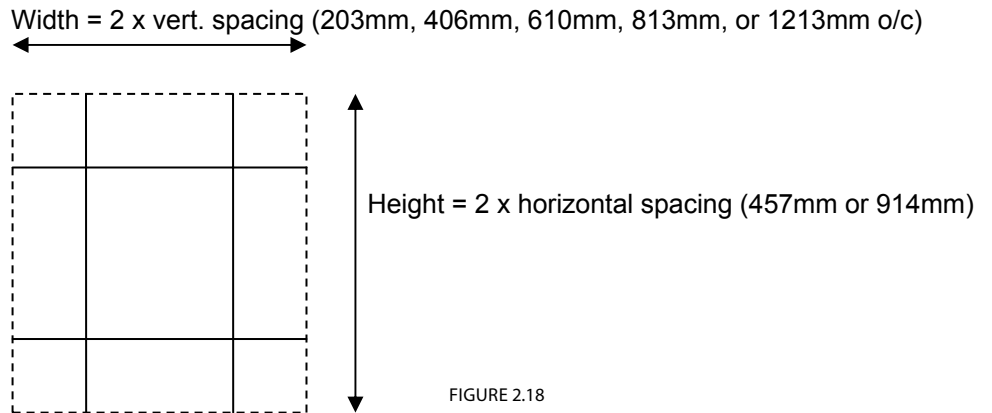

FIGURE 2.18

REBAR = LMPER x HW x
MULTIPLIER (Table 2.2.2.1)

The linear meter of the wall is multiplied by both the height of the wall and by value obtained in Table 2.2.2.1 which is a constant. The result is in meters. This constant is for a rebar grid in the wall 0.457m x 0.406m horizontally and vertically respectively with an allowance for horizontal splices.

Table 2.2.2.1

	Vert. o/c Spacing (mm)	Horiz. o/c Spacing (mm)	Ratio LM/SM of Wall Single Mat	Ratio LM/SM of Wall Double Mat
Vertical Only Steel Mat	203	-	4.92	9.84
	406	-	2.46	4.92
	610	-	1.64	3.28
	813	-	1.25	2.50
	1213	-	0.82	1.64
Horizontal Only Steel Mat	-	457	1.08	2.16
	-	914	7.12	14.24
Combined Steel Mat	203	457	5.48	10.96
	203	914	4.36	8.72
	406	457	3.84	7.68
	406	914	2.72	5.44
	610	457	3.41	6.82
	610	914	2.33	4.66
	813	457	3.02	6.04
	813	914	1.90	3.80
	1219	457	4.92	9.84
	1219	914	3.28	6.56

TO CALCULATE THE VOLUME OF CONCRETE:

$$\text{m}^3 \text{ of CONCRETE} = \text{LMPER} \times \text{HW} \times \text{Concrete Multiplier (Table 2.2.2.2)}$$

The concrete multipliers shown in Table 2.2.2.2 (below) are constants, each of which represent the total volume of concrete (in cubic yards) that is necessary to cover 1 square meter of wall area for the specified core thickness of form. To calculate the amount of concrete required to fill the wall, simply multiply the total area of the wall (in square meters) by the multiplier shown for the selected core thickness of form. The volume of concrete ordered should be reduced in accordance with window and door openings. If using a concrete pump as a method of placement, an allowance must be included within the calculated volume of concrete to account for waste. NUDURA recommends an additional concrete volume of 1 m³ to 2 m³ for the pump unit.

Table 2.2.2.2

CONCRETE CORE SIZE	CONCRETE MULTIPLIER
102 mm	0.102
152 mm	0.152
203 mm	0.203
254 mm	0.254
305 mm	0.305

TO CALCULATE THE NUMBER OF VERTICAL JOINT CLIPS:

$$\text{VJC} = (\text{LPPER} \div 2.44\text{m} \times 4 \text{ per standard} \times \# \text{ of courses}) + (\# \text{ of Corners} \times 4 \times \# \text{ of courses})$$

The VJC formula takes the lineal footage of the perimeter of the structure and divides by the length of a standard form. Then multiply this by 4 per standard form and then multiply again by the number of courses. The second part of this formula then takes the number of corners and multiplies by 4 clips per corner and then multiplies by the number of courses.

Note: Remember that what is in the brackets must be completed before adding them together for the total number of clips.

GETTING STARTED

ESTIMATING FORMULAE SUMMARY (METRIC)

STANDARD FORM UNITS:

Gross Wall Area (m²) = Total Linear footage of wall (m) x Total Height (m)

Net Wall Area (m²) = Gross Wall Area (m²) – Total area of openings (m²)

Total Standards/course = (Total Lineal meters of wall – (# 90° Corners x 4) – (# 45° Corners x 3)) ÷ 2.44

Total Standards before deductions = Total Standards/course x # of courses

Standards (BL) = Lineal meters of Brick Ledge ÷ 2.44

Standards (TT) = Lineal meters of Taper Top ÷ 2.44

Standards (OP) = ((LMOP x # COP) ÷ 1.219) ÷ 3

Standards (TF) = (# of T Forms x # of courses) ÷ 0.61

TOTAL STANDARDS = Total Standards before deductions - Standards (BL) - Standards (TT) - Standards (TF)

90° FORM UNIT: 90° FORM = #90 x #C

45° FORM UNIT: 45° FORM = #45 x #C

T FORM UNIT: T FORM = #T x #C

BRICK LEDGE FORM 1.22m UNIT: BLF = LMBLF ÷ 1.22

BRICK LEDGE FORM 2.44m UNIT: BLF = LMBLF ÷ 2.44

BRICK LEDGE EXTENSION: BLE = LMBLE x .375
of Screws = BLE x 6

OPTIMIZER FORM UNIT: OP = (LMOP x # COP) ÷ 1.219
OP Ties = OP x 6

HEIGHT ADJUSTER: HA = LMPER x .75 x #CHA
HA Ties = (HA ÷ 2) x 4

WATERPROOFING: WP = LMWP x HWP ÷ 19.5

PARGING COAT: PC = LMPAR x HPAR ÷ 6.97

FIBER MESH: FM = LMPAR x HPAR ÷ 44.1

WALL ALIGNMENT SYSTEMS: WAS = LMPER + 1 per corner or tees ÷ 1.63

REBAR: REBAR = LMPER x HW x MULTIPLIER (Table 2.2.2.1)

CONCRETE: Concrete = LMPER x HW x Concrete Multiplier (Table 2.2.2.2)

VERTICAL JOINT CLIPS: VJC = (LFPER ÷ 2.44m x 4 x #C) + (# of Corners x 4 x #C)

ESTIMATING RADIUS WALLS (METRIC)

For determining total number of radius forms required for on site construction of a NUDURA radius wall or for preparing an order for factory cut NUDURA radius forms, you can use the calculation formula below. This formula assumes that any radius constructed will be an “arc length segment” of a full circle with a known angle of rotation:

The following information is required to determine total number of radius forms for any given radius wall in a floor plan:

1. The Outside radius (measured in millimeters) from the focus point to the outside face of the NUDURA form
2. The inside radius (equals the Outside radius (in millimeters) less the total form thickness being used)
3. The Degrees of Turn of radius (this is total number of degrees of rotation that the radius covers of a full circle)
4. The Total Wall Height (measured in millimeters).

TO CALCULATE THE TOTAL NUMBER OF RADIUS FORMS REQUIRED:

No. of forms per course		No. of courses
No. of Forms = Outside radius (in mm) x 6.283 x (Degrees of Turn of Radius/360)	X	Wall Height (in mm)
2438		457



NOTES:

1. To assure adequate product for accommodating custom fitting of the wall forms into the standard elements of the plan, the first part of the calculation (no. of forms per course) above should be **ROUNDED** up to a whole number or (full form length) before multiplying by the number of courses of forms required.
2. Do NOT deduct any allowance for openings particularly if placing orders at the factory for custom radius forms.

As an alternate, you can also obtain NUDURA’s radius wall form unit spread sheet calculator through your distributor which enables the same calculation to be performed in Microsoft excel® along with giving the required cut segment lengths. (The distributor can also duplicate the quantity portion of this calculator by entering data into the NUDURA radius wall digital order form).

Further guidance on estimating for NUDURA radius walls is available through your NUDURA distributor Or can be downloaded directly from the Construction Professional Section of NUDURA’s Website under “Technical Bulletins and Guides”.

2.2.3 FORM UNIT CONCRETE VOLUMES

Form Unit	Form Coverage	Form Volume	Form Volume	Form Volume
	Form Coverage	100	100	100
	Form Volume	100	100	100
	Form Volume	100	100	100
	Form Volume	100	100	100
	Form Volume	100	100	100
	Form Volume	100	100	100
	Form Coverage	100	100	100
	Form Volume	100	100	100
	Form Volume	100	100	100
	Form Volume	100	100	100
	Form Volume	100	100	100
	Form Volume	100	100	100
	Form Coverage	100	100	100
	Form Volume	100	100	100
	Form Volume	100	100	100
	Form Volume	100	100	100
	Form Volume	100	100	100
	Form Volume	100	100	100
	Form Coverage	100	100	100
	Form Volume	100	100	100
	Form Volume	100	100	100
	Form Volume	100	100	100
	Form Volume	100	100	100
	Form Volume	100	100	100
	Form Coverage	100	100	100
	Form Volume	100	100	100
	Form Volume	100	100	100
	Form Volume	100	100	100
	Form Volume	100	100	100
	Form Volume	100	100	100

Model	Material	Unit Weight (kg/m)	Standard Length (m)	Standard Weight (kg)
Model 1 - Single Flange (mm)	Wall Cladding	1.14	1.20	1.37
	Roof Cladding	1.14	1.20	1.37
	100x100x10	1.14	1.20	1.37
	100x100x12	1.14	1.20	1.37
	100x100x15	1.14	1.20	1.37
	100x100x20	1.14	1.20	1.37
Model 2 - Single Flange (mm)	Wall Cladding	1.14	1.20	1.37
	Roof Cladding	1.14	1.20	1.37
	100x100x10	1.14	1.20	1.37
Model 3 - Double Flange (mm)	Wall Cladding	1.14	1.20	1.37
	Roof Cladding	1.14	1.20	1.37
	100x100x10	1.14	1.20	1.37
	100x100x12	1.14	1.20	1.37
	100x100x15	1.14	1.20	1.37
	100x100x20	1.14	1.20	1.37
Model 4 - Double Flange (mm)	Wall Cladding	1.14	1.20	1.37
	Roof Cladding	1.14	1.20	1.37
	100x100x10	1.14	1.20	1.37
	100x100x12	1.14	1.20	1.37
	100x100x15	1.14	1.20	1.37
	100x100x20	1.14	1.20	1.37
Model 5 - Triple Flange (mm)	Wall Cladding	1.14	1.20	1.37
	Roof Cladding	1.14	1.20	1.37
	100x100x10	1.14	1.20	1.37
	100x100x12	1.14	1.20	1.37
	100x100x15	1.14	1.20	1.37
	100x100x20	1.14	1.20	1.37
Model 6 - Triple Flange (mm)	Wall Cladding	1.14	1.20	1.37
	Roof Cladding	1.14	1.20	1.37
	100x100x10	1.14	1.20	1.37
	100x100x12	1.14	1.20	1.37
	100x100x15	1.14	1.20	1.37
	100x100x20	1.14	1.20	1.37

2.3 BUILDING PERMIT SUBMISSION REQUIREMENTS

If a Builder or Contractor is submitting for permit on a NUDURA Building with custom stamped documentation that has been overseen by a professional engineer, normally permit submission to a Building Department can proceed with little delay. However, this section of the manual is intended to provide suggestions to the contractor who has never submitted for permit before using NUDURA Integrated Building Technology. The suggestions provided here, as academic as they may be, will help a permit submission to go as smoothly as possible.

First: understand that the Building Official needs to be able to reference an enabling piece of legislation that ensures the engineering specifications for the building are provided for under local jurisdiction.



FIGURE 2.19

USA

The US National Code Agency “The international Code Council” is responsible for administering the 2003, 2006 and 2009 international residential Building Codes. The local municipality, dependant upon State, may have already adopted one of the three codes mentioned above or is well on its way to doing so. These codes contain prescriptive structural design tables for both below grade and above grade reinforcing steel requirements, as well as typical lintel designs tables. These tables are referenced within NUDURA’s ICC-ES evaluation report (ESR-2092). A copy of this evaluation report can be downloaded from NUDURA’s web site and should be submitted to the building department for permit approval.

CANADA

Since 2005, prescriptive structural design tables and scope of applicability limits are also have been provided under the Housing and Small Buildings section of the National Building Code (Part 9) and under Part 9 of the Ontario, Quebec, Alberta and British Columbia Building Codes.

In either case (USA or Canada) the design builder or contractor can ensure a much smoother permit submission and direct acceptance of the Building Official if the following guidelines are applied during plan submissions.

First, since the local Building Official may not have seen NUDURA before, ensure that he or she has a copy of 2 important documents:

- (a) The NUDURA Installation Manual
- (b) The applicable NUDURA evaluation report or Intertek Product Certification Documentation for your region

USA - ICC-ES – ESR-2092

CAN - Intertek Certification Documentation to CAN/ULC S717.1 and its related documents

Europe - EOTA- Eta-07 0034

Other State, Provincial or Regional approvals may be required to be included with the permit submission to demonstrate the system’s compliance with these provisions as well. if you are unsure, check with your distributor. They can advise you on the additional documents that may be required for your specific region. These documents are summarized in the following section, (Section 2.4).

2.4 EVALUATION REPORTS AND APPROVALS

USA EVALUATIONS AND APPROVALS

National:	<ul style="list-style-type: none"> • Certified to: ASTM E 2634 • ICC-ES (AC-353) 	Intertek: SDID No. 21903 ESR-2092 (TYPES I-V/ N/C, A&C*)
State:	<ul style="list-style-type: none"> • State of Florida 	FL1585-R3
County/City:	<ul style="list-style-type: none"> • Miami Metro Dade • City of New York 	NOA 16-0627-01 Complies with OTCR 2009-020

**Approved for use in "Attics and Crawlspace" uncovered per report conditions*

CANADA EVALUATIONS AND APPROVALS

National:	<ul style="list-style-type: none"> • Certified to: CAN/ULC S717.1 	Intertek: SDID No. 21903
-----------	--	--------------------------

EUROPE EVALUATIONS AND APPROVALS

International:	<ul style="list-style-type: none"> • European Union of Technical Assements (EOTA) Assessed in Compliance with EOTA: ETAG 009 • British Board of Agrément (BBA) ETA-07/0034 	
France:	<ul style="list-style-type: none"> • CSTB (Based on ETA 07/0034) • ACERMI Issuing Summer 2017 	DTA 16/09-581

MIDDLE EAST EVALUATIONS AND APPROVALS

United Arab Emirates:	<ul style="list-style-type: none"> • Certified to ASTM C78 • Dubai Central Laboratory: 	CL 16020326
-----------------------	--	-------------



2.5 BUILDING DEPARTMENT: TYPICAL EXPECTATIONS



FIGURE 2.20

Most building departments have put together a set of guidelines of necessary documentation that needs to be included with any submission to obtain a building permit. Without these documents, permit delays can occur costing time and money for any project. It is imperative that whoever is submitting for the building permit communicate with the building department and ask them for a list of required documentation. Remember that the building department cannot make assumptions about the building process as in many cases the building department can have a number of internal departments reviewing a set of plans.

NUDURA has included here a list of potential documents that might be required for submission to a building department to gain a building permit for a building using the NUDURA Form System.

Note: This list is only a guide and is not intended to override any existing requirements a building department might already have in place.

Completed set of working drawings

Floor Plans

- Show that NUDURA ICF is being used by some means- either on the plans directly or notes outlining INTENTION to substitute the conventional construction method shown with NUDURA.
- List the size and spacing of the vertical and horizontal reinforcing steel and make reference from where this was obtained.
- If beam pockets are needed, show location and reference any additional reinforcing steel necessary.

Elevations

Building Section Drawings

- Show floor to floor heights for each story
- Exterior Finishes
- Interior Finishes
- Backfill Heights
- Footing Sizes

Relevant Detail Section Drawings

- Include photocopies of any details from this manual
- Floor Connection Details
- Roof Connection Details

Don't forget to ensure that the drawing set has been produced to include the data outlined under Section 2.1 "Drawing and Contract Document Preparations". This will help the Building Official to understand all of the prescriptive elements being covered in the design and avoid any question both during plan examination and subsequent inspection on site.

And finally be sure to include copies of:

- The applicable evaluation report for the site
- Additional regional documentation as may be required
- Structural Table Data to corroborate design
- Lintel schedule, if produced separately

2.6 PRE CONSTRUCTION PLANNING

To ensure that the project is successful, it's important to start with a detailed plan of action before any work commences. Having a plan of execution is just as important as a detailed building plan, and this will help the contractor avoid costly delays in construction along with bringing the project in on budget. The following steps will ensure the project gets started on the right path to completion.

STEP 1: UNDERSTAND THE PROPERTY: identify the services that will need to be brought into the building. Determining the necessary services and the connection points, will allow the contractor to plan entry locations for penetrations going through the wall section.

Obtain all the necessary permits, and become familiar with the local by-laws and covenants for the area before construction. Remember that soil conditions and the lot elevations will have an effect on footing (footer) sizes and building elevation for the area. Water tables may also dictate the elevation of a building and it is recommended that a contractor check with local residents for any water issues in the area – particularly any seasonal flood issues that can assist in setting final elevation of the building OUT of potential water problems down the road. Matching the building elevation with property slopes will ensure proper drainage away from the building once construction is completed. It will also be beneficial to plan the building's finished elevation to meet surrounding properties and the finished elevations. Consulting a professional for site planning and drainage planning will ensure costly maintenance in the future can be avoided.



FIGURE 2.21

STEP 2: SITE PREPARATION: As with any construction site, heavy construction equipment is necessary for completion of the project. NUDURA Integrated Building Technology is no different as there will be large delivery vehicles, heavy excavation equipment, and concrete trucks and pumps entering the property. All of these vehicles will require additional room to maneuver around the site to effectively perform the tasks needed to complete the project. Depending upon soil conditions, a solid sub base for the driveway will ensure the above mentioned pieces of equipment can maneuver around the site with ease. This will also help to compact the soil, which will limit settlement once the finished grade is determined. Also make sure that there is room for any pieces of equipment needing to swing booms into the structure without interference from electrical lines, neighboring dwellings, and any other dangerous obstructions.



FIGURE 2.22

Now that the above steps have been reviewed, the contractor has the necessary plan to move forward with construction of the building. These items need to be documented for site plan submission to the local building department and are an essential part of the package the home owner requires, keeping on file for future maintenance of the property.

3.0 TOOLS

The list below is intended to provide the contractor and their workers a guide for what tools are required on most NUDURA Projects. Although not all of these tools will be necessary for every project, the vast majority are essential to achieving an efficient NUDURA build.

3.1 STANDARD CONSTRUCTION TOOLS

- | | |
|---|---|
| Tape Measure** | Utility Knife** |
| Electrical Pliers / Side Cutters | Keyhole Saw |
| Chalk Line / ink Line | Laser Level/ Transit |
| Loop Tie Twister | Portable Table Saw*** |
| String Line | 48" (120 cm) min. Hand Level*** |
| Cordless or Corded Drill / Hammer Drill | Steel Cutting Saw*** |
| Hammer** | Framing Square*** |
| 12" (30 cm) Hand Saw | Various Drill /Screw Bits*** |
| Tin Snips | Generator*** |
| Reciprocating Saw | Stepladders*** (Standard & 3-step Low rise) |
| Pruning Saw** | |



3.2 STANDARD CONCRETE TOOLS

- ¾" (19 mm) Head Concrete Vibrator
- Irish Wall Shovel (Concrete forming shovel)
- Concrete Trowels



3.3 NUDURA RECOMMENDED TOOLS

- | | |
|---------------------|-------------------------------------|
| Rubber Mallet** | NUDURA Alignment/Scaffolding System |
| Bolt Cutters | Reinforcing Steel Bender/Cutter |
| Pruning Saw** | Hot Knife Tool |
| Foam Dispensing Gun | Pruning Shears |
| Electric Chainsaw | |



3.4 MISCELLANEOUS SUPPLIES

- | | |
|----------------------------------|--|
| Planking for Alignment System | Various Strapping /Plywood |
| Various Screws* | ¼" Hex Head Nut Driver |
| NUDURA Low Expansion Spray Foam* | Square Head Driver Bit |
| 1" (25 mm) Fiber Tape* | 4" (100 mm) interlock Protection Tape* |

*As shown in NUDURA's Product guide

**Tool should be available for each construction crew member

***Tool can be shared between construction crew members

3.5 CONSTRUCTION MATERIALS LIST

3.5.1 BELOW GRADE MATERIALS

- | | |
|-----------------------------|--------------------------------------|
| NUDURA Form Units | NUDURA Peel & Stick Membrane |
| Reinforcing Steel | NUDURA Low expansion Spray Foam |
| Vertical Joint Clips | Window Buck Materials |
| Tie Wire | NUDURA Alignment System |
| Strapping 1"(25 mm) | Fiber Tape |
| Floor Connection System | 4"(100 mm) Interlock Protection Tape |
| Service Penetration Sleeves | |



3.5.2 ABOVE GRADE MATERIALS

- | | |
|---------------------------------------|----------------------------------|
| NUDURA Form Units | Rain Screens Drip Edge Membranes |
| Reinforcing Steel | NUDURA Parging Material |
| Vertical Joint Clips | NUDURA Fiber Mesh Material |
| Tie Wire | NUDURA Low Expansion Spray Foam* |
| Strapping | Window / Door Buck Materials |
| Floor/ Roof Connection System | NUDURA Alignment System |
| Service Penetration Sleeves | 1"(25 mm) Fiber Tape* |
| 4"(100 mm) Interlock Protection Tape* | NUDURA Masonry Ties |



3.5.3 ROOF CONNECTION MATERIALS

- Anchor Bolts
- Sill Plates
- Multi-purpose Roof Anchor System



4.0 SITE PREPARATION & DELIVERY

4.1 PRE-PLANNING OF SITE

As with all projects, site preparation is an essential element to ensuring a building is constructed on solid ground. As all contractors know, any excavation of a site must ensure that any organic materials must be removed from the footprint area of the structure being built.

Clean project sites will ensure productivity, efficiency and safety on the work site. When reviewing the site plan it is always important to remember to plan ahead for such things as backfill placement, truck access for material delivery, product storage & protection from damage, boom truck positioning, concrete truck access, and finally safety of all workers.



FIGURE 4.01

4.2 BACKFILL PLACEMENT

Work sites may have limited storage capacity and the option to transport excavated materials to another site may need to be considered. This will ensure that the excavated materials do not impede access to the site nor cause an unsafe working environment (i.e. avoiding excess material slides into the excavated area endangering the workers or causing construction delays).



FIGURE 4.02

4.3 TRUCK ACCESS FOR MATERIAL DELIVERY

Access for proper delivery of product to the site is also an essential key to maintaining an efficient, safe site. The access from the main road should be wide enough to allow a large truck and trailer the opportunity to back in without concern of being stuck due to poor site conditions. It is also essential that enough people are present to unload the truck without delay. In some cases the drivers will often help in off loading, but this should never be expected of the delivery person.



FIGURE 4.03

4.4 PRODUCT STORAGE AND PROTECTION FROM DAMAGE

You'll need a place for product to be stored safely on site without any chance for damage prior to use. Designate an area of the site as a drop zone and storage area for products being used on the site. This will ensure when other heavy equipment is present on site the chance of damage occurring to the products is kept to a minimum. Although NUDURA's products come wrapped, bagged, or boxed, should inclement weather threaten the work site, additional coverage should be used to protect the products until they are used. It can also be advantageous to tarp the products should they be exposed to prolong periods of ultraviolet rays.



FIGURE 4.04

4.5 BOOM TRUCK POSITIONING

Of the various methods available for concrete placement, a boom pump is probably the most efficient equipment to consider. Remember that the positioning of this equipment is critical to ensure access to every area of the building project. This will make for an efficient step in the construction process that will not require continually moving the equipment to reach the furthest point of the building. Remember that when using any type of boom truck, it is essential that the operator has been made aware of all power wires and any other dangerous obstacles.



FIGURE 4.05

4.6 CONCRETE TRUCK ACCESS AND TIMING

Crucial to continuous feed of the boom pump, remember that the concrete trucks will also need proper access to the site and specifically to the boom hopper. Depending upon the area of the build, trucks might not have parking capabilities on the roadway. Timing of these trucks is essential to ensure no additional delays or fines occur on pour days. If the site conditions are wet or the ground area is boggy, the additional weight of both concrete and boom trucks are best planned for by preparing a temporary roadway of rock and gravel to adequately take the weight of these heavier vehicles. Also, an area for these trucks to wash any excess concrete off of the truck should also be considered as this needs to be a separate area away from the building and other equipment.



FIGURE 4.06

4.7 SAFETY (OVERHEAD WIRES, EXCAVATION PROTECTION)

Finally, as with all construction sites, safety must take priority to ensure the workers do not get hurt. This ensures productivity on the site is not jeopardized and man-hours are not lost due to injury. Ensure that all overhead wires, main services, trenches and any excavation from the foundation have been noted and necessary precautions have been taken to prevent injury.



FIGURE 4.07

5.0 NUDURA PRODUCTS ON SITE STORAGE PACKAGING, UNIT ASSEMBLY, USAGE

NUDURA Inc. has one of the most complete lineups of products and accessories available today in the construction industry. NUDURA's Integrated Building Technology is unique in the respect that the form lineup includes assembled forms along with unassembled panels, which allows for greater flexibility to achieve complex designs. Along with these forms, NUDURA Inc. carries the most extensive lineup of accessory products that enhance the most advanced product in the market

5.1 PRODUCT PACKAGING

The manner by which NUDURA material arrives on the building site and what preparations may be necessary with the materials before installation begins is the basic purpose of this section.

For the vast majority of NUDURA's Integrated Building Technology Product Line-up, the forms (or ancillary products) are either wrapped in plastic, or put into boxes. Below is a chart of NUDURA's core products and how they are packaged for when they arrive on site;

Product Name	Wrapped in Plastic	Box	Taped
Standards	✓		
90° Corners	✓		✓
45° Corners			✓
T Forms	✓		✓
Brick Ledge Forms	✓		
Taper Top	✓		
Brick Ledge Extensions		✓	
Radius Wall	✓		
Optimizer	✓	✓	
Height Adjuster	✓		
End Caps		✓	
Unassembled Panels	✓		
Insert Webs		✓	
Floor Technology	✓		
Ceiling Technology	✓		

OPENING & SET-UP OF NUDURA PRE-ASSEMBLED VERSUS SITE ASSEMBLED FORM COMPONENTS

As discussed in Chapter 2, NUDURA products come in either fully assembled forms or component assembled products that the installer manually assembles on site. Chances are that 90 to 95 percent of any job you execute will be with NUDURA's fully assembled form components. Specialty top course forms – radius wall forms or T forms – will usually be the only exception to this general rule.

NUDURA's form technology (and the wide scope of its installation flexibility) is based on the deployment of two patented hinge and web assembly types that are both incorporated into the form system:

1. Integrally molded steel hinge pin webs that form part of both the cross tie and the fastening strip component of the web
2. Separate molded HD Polypropylene insert webs which slide fit into HD Polystyrene Web fastening strips that are integrally molded into the insulation components of either a fully assembled form OR separate molded insulation panels, or form profiles which are either partially or fully assembled into a form or remain completely unassembled allowing the form to be shipped as a flat panel set that will be assembled manually on site.



FIGURE 5.01

The key difference from other component assembled form systems on the market is that for NUDURA's primary market Standards and Corner forms, there is no need to execute any pre-assembly. The opening of the forms as described below can easily occur as part of the assembly of the form into the wall.

STANDARD FORMS, 6" AND 8" (152 mm AND 203 mm) BRICK LEDGE AND TAPERED TOP FORMS

Standard Forms for NUDURA's 4" (101 mm) core through to 12" (305 mm) Core Forms, as well as 6" (152 mm) core. Pre-assembled Brick Ledge and Tapered Top Forms come factory assembled with NUDURA's patented integrally molded steel hinge pin web fastening strip system. The 8" (203 mm) core Brick Ledge and Tapered-Top Forms, also arrive at the site factory assembled, but are constructed with standard panels using NUDURA's insert webs and NUDURA Panels with polystyrene web fastening strips.

The forms arrive shrink-wrapped in bundles of 3 forms per bundle – each bundle weighing approx 45 lbs (20.4 kg). When folded flat, the form is basically a fully collapsed parallelogram with one form panel slid forward of the other during shipping and storage. NOTE: depending upon your area, the Brick Ledge Forms are available as either 4' (1.22 m) or 8' (2.44 m) length forms. Check with your distributor to know which form type is available in your area and be sure your quantity of forms reflects the unit length available for your region.



FIGURE 5.02

Once the plastic shrink wrap is slit and peeled off, opening the form is easy. The user simply places the form so that the lower of the 2 panels is the one closest to their body. Placing this panel against the abdominal muscles (See Figure 5.03), the user firmly grabs the upper panel and pulls it towards themselves until the hinge webs are opened to a position fully perpendicular to the panels.



FIGURE 5.03

CORNER FORMS

Both 90° and 45° corner forms for all core thicknesses are also shipped folded for maximum efficiency, but, as noted in Chapter 4, are always shrink wrapped and shipped nested in pairs, stacked 6 forms to a bundle, end to end, to resemble the length and bulk of the shrink wrapped standard bundles. Again, as noted in Chapter 4, these forms are stored interlocking, facing up and down, to protect the nested corner components from damage due to vertical stacking pressure. All corner forms are assembled with a combination of hinge pin and insert webs, the hinge pin webs always comprising of the 2 outer most webs on the long end of the form, and the last web before the corner being a pre-assembled insert web/polystyrene fastening strip combination. This maximizes the forms' strength at the corner condition.

Once unwrapped, the only difference from the Standard Forms is to unfold the nested interior and exterior panels, pull out the stowed, unassembled insert web (included with each form), and insert it into the web capture lugs of the polystyrene fastening strips located on the short end of the corner. This completes the corner assembly ready for placement.



FIGURE 5.04

SPECIALTY FORMS, T FORMS AND FACTORY CUT RADIUS FORMS

All above noted forms arrive shrink-wrapped as separate panel components molded with web fastening strips and (depending on product) may or may not require separate insert webs to be ordered in box quantities as part of the order. Double check your product catalogue or with your NUDURA distributor directly to be sure. Specialty forms include ANY of the following:

- 4", 10" and 12" (102 mm, 254 mm, and 305 mm) Taper Topped Forms
- 4", 10" and 12" (102 mm, 254 mm, and 305 mm) Brick Ledge Forms
- Double Sided Tapered Top Forms any core thickness
- Double Sided Brick Ledge Forms any core thickness
- T Form units and Core Thickness combination or common core size
- Factory Cut Radius Forms

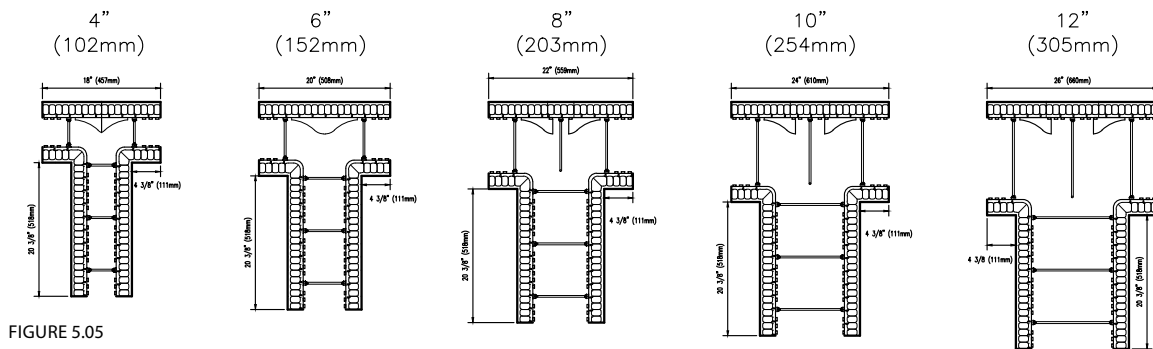

FIGURE 5.05

For Double Sided Tapered Top Forms and Double Sided Brick Ledge Forms, the products will arrive to site shipped with separate standard panels. This is because the same molds that are used for forming standard assembled tapered top and one side brick ledge forms are used for these products as well with fastening strips installed instead of fully assembled hinge pin webs. Be sure you accommodate for these nuances on your product counts and quantities.



FIGURE 5.06a



FIGURE 5.06b

With T Forms, the main wall exterior panel is also molded from a common sized mold that is intended to be adapted for ALL core thicknesses of T Form. For this reason, remember that the main wall panel will require component assembly and form support on site for 4", 10" and 12" (102 mm, 254 mm, and 305 mm) core forms.

Additionally note that factory cut radii components when shipped will consist of full length 8' panels and multiple custom cut interior panel segments each less than 8" in length to suit the radii noted. Always keep these components separate and designated to their intended radius if multiple radius walls are being installed on site. Prep work for the main exterior panel may be required which is covered in the Bulletin pertaining to radius Walls found in Appendix F.

5.2 NUDURA ALIGNMENT SYSTEM

SITE ARRIVAL AND PACKAGING

NUDURA's Alignment System is available with 8' (2.44 m), 10' (3.05 m), and 12' (3.66 m) box channels. All components fit neatly in a steel crate that holds 20 complete sets of bracing. Should replacement parts need to be ordered the chart below will give the contractor/installer the part name and number for the alignment system components.

Part Name	Part Number
Turnbuckle	TBUKL
Base Plate	BPLATE
Catwalk Bracket	CATBRA
Guard Rail Post	GRAIL
1/2" (13mm) Gravity Pin	G-PINS
8' (2.438m) Box Channel	CHA-8
10' (3.048m) Box Channel	CHA-10
12' (3.658m) Box Channel	CHA-12



FIGURE 5.07

5.3 NUDURA FORM-LOCK



FIGURE 5.08

SITE ARRIVAL AND PACKAGING

The form lock NUDURA uses within the form cavities is specifically manufactured to the specifications of the forms. NUDURA FORM-LOCK comes in widths that fit within the wall cavities of the 6" (152 mm), 8" (203 mm), 10" (254 mm), and finally the 12" (305 mm) form units. All FORM-LOCK sizes are available in 100' (30.5m) and are bundled in 100' (30.5m) packages.

USES

NUDURA FORM-LOCK can be used in multiple areas of the project and its primary function within the NUDURA Integrated Building Technology is to ensure the walls maintain straightness. NUDURA recommends that FORM-LOCK be used in the second course of forms and in every 3rd or 4th course after that. Additional uses are in vertical stack joints and window sills to ensure these areas maintain straightness until the concrete has cured.

5.4 VERTICAL JOINT CLIPS

FIGURE 5.09



SITE ARRIVAL AND PACKAGING

The vertical joint clips are pre-bent steel wire that enables locking at the vertical joints of the forms and are packaged with 200 clips per box. The clips are 8 5/8" (219 mm) in length and clip onto the web where it connects to the EPS.

USES

The vertical joint clips are to be used for connecting corner forms to the standard form units. The purpose of the vertical joint clip is to replace the use of tape or tie wire and to provide a solid secure connection with minimal amount of labor. This helps in ensuring no additional movement occurs during concrete placement with the forms. Typically the installer will use 8 vertical joint clips per corner to standard connection, and 4 clips for the standard to standard connection on the first course of forms. All subsequent courses will only require 4 in the corner to standard connection and 2 in the standard to standard connection. Proper installation of this product is discussed in chapter 6 of this manual.

5.5 V-CLIPS

SITE ARRIVAL AND PACKAGING

Like the vertical joint clip, the V-Clip is a pre-bent galvanized steel wire accessory that is useful in multiple applications but is more suited to specific attachment requirements in commercial construction, or where concrete floor decks are being used in conjunction with NUDURA. The clips come in boxes of 250. They measure 8" (203 mm) wide x 10" (254 mm) long and feature prongs at each end of the V-clip about 1 ½" (38 mm) in length that are inserted into the web connection lugs of NUDURA's standard 8' (2.4 m) panels.

USES

The V-Clip Accessory's primary function is to help stay the free end of NUDURA 8' (2.4 m) standard panels in position wherever a concrete precast floor connection is anticipated. Once the precast panel is in place, the V-Clips are installed at 16" (406 mm) centers down the length of wall by drilling holes in the hollow core slab approx. 10" (254 mm) away from the inside face of the NUDURA panel and longitudinally down the axis of the wall midway of every other web space. The prongs on the clips are inserted into the panel connection lugs and then secured at their bend apex into the drilled holes using a tie wire insert and nail or screw sized to suit the hole. This technique can be adapted to suit any condition where the top condition of a NUDURA panel must be stayed in position horizontally for subsequent construction of a floor pour.

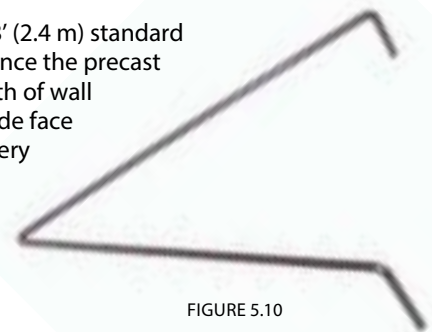

FIGURE 5.10

5.6 FORM TRANSITION BRACKET

SITE ARRIVAL AND PACKAGING

The Form Transition Bracket is a stamped galvanized metal plate accessory that is useful in supporting the free panel of any NUDURA form of a differing core thickness from the form thickness installed below it. During wall construction and concrete placement. The bracket measures about 1 ½" (38 mm) in width x 8" (203 mm) in length and feature stamped cleats that are pre-designed to clip over 15M or No. 5 diameter reinforcing steel. This accessory comes in boxes of 100.

USES

The bracket can be used to support the free panel (either inside or outside) of a NUDURA form whenever a transition from a greater to lesser core thickness of form is anticipated (i.e. moving from a 10 inch (254 mm) tapered top form to a standard 6 inch (152 mm) core form to create a brick ledge condition). The brackets are typically installed every 2nd or third web by simply clipping the stamped lugs onto the closest supporting reinforcing steel bar, installed in the top of the wider core form below and aligning the bracket to the web and face surface of the form, then screwing it into place once the form above has been leveled to its required height.



FIGURE 5.11

5.7 NUDURA SPRAY FOAM, FOAM GUNS AND GUN CLEANER SOLUTION

SITE ARRIVAL AND PACKAGING

NUDURA Spray Foam is a polyurethane based low expansion foam that is shipped in boxes of 12 – 24oz (680g) cans per box.

The foam guns are shipped by box – 1 pc/box and gun cleaner arrives also in boxes of 12 cans per box.

USES

NUDURA Spray foam, guns and gun cleaner products are indispensable on a NUDURA Site, enabling the installer to tackle everything from quick tack anchorage of the forms to the footings or slab at 2nd course leveling, additional form support or adhesion during assembly of cut components such as panels or radius wall components, filling in cut imperfections of EPS panel joints, filling cut gaps around insert sleeves, completing airtight window opening seals and so on.



FIGURE 5.13



FIGURE 5.12

5.8 MASONRY TIES

SITE ARRIVAL AND PACKAGING

The NUDURA Cast in Place (C.I.P) masonry tie system is available in galvanized or stainless steel and is shipped in 2 boxes; 100 wall ties and 100 pintles.

The NUDURA Surface Mount masonry tie system is available in galvanized steel and ships in one box of 100 pieces. Pintles are available separately in one box of 100 pieces.

USES

The CIP Masonry Tie was specially designed to a wide loop profile with sharp pointed ends to allow cast tie portion of the accessory to be pressed through the exterior EPS foam panel under normal hand pressure. This eliminates the need to cut the foam for installation into the wall, which can compromise the strength of the form during the concrete pour (figure 5.14).

The Surface Mount Masonry Tie (galvanized) was designed to be fastened with 2 NUDURA Hex head Screws anywhere on the NUDURA fastening strip. This tie will accept NUDURA Pintels and other smaller dimension pintels. The surface mount masonry tie is manufactured with stops that penetrate the foam but prevent the tie from being over tightened and compressing the foam (figure 5.15).



FIGURE 5.14



FIGURE 5.15

6.0 INSTALLATION PROCEDURES

INTRODUCTION

The purpose of this section of the manual is to give a detailed description of proper installation methods of NUDURA's Integrated Building Technology. It is also intended to make sure all the necessary steps are taken to ensure a successful build occurs.

As outlined in Chapter 4, site preparation will play a key role in ensuring the following installation procedures are completed most efficiently and that the project is successful. This chapter is laid out similarly to how a typical building is constructed; starting at the footings and ending with the exterior finishes that can be applied to NUDURA®'s Integrated Building Technology.

6.1 FOOTINGS

Footings are designed to transfer and distribute the loads applied from the building structure without exceeding the safe load bearing capacity of the soil or rock on which they bear. **IMPORTANT!** The footing should be placed on undisturbed native soil or a compacted granular base as per local code requirements. The footing depth must be equal to or greater than the distance that the footing projects beyond the face of the concrete wall inside the form.

Very often, it is the contractor who is tasked with correct sizing of the footing width and thickness during construction (in accordance with local Building Codes). If you have never worked with NUDURA before, when it comes to footing sizing, always remember that "edge projection distance" is the distance from the concrete wall surface **INSIDE** the NUDURA form to the footing edge – **NOT** the exterior wall surface of the EPS foam to footing edge. Therefore, **BE SURE** in your calculations to **ADD 2 5/8" (67 mm)** to **EITHER SIDE** of the distance of edge projection of when determining correct corresponding **THICKNESS** of footing.

if a design is specifying brick or stone veneer above grade to be carried on a brick ledge form, always remember that the NUDURA system **CANTILEVERS** the brick veneer **BEYOND** the face of the insulation of forms extending to the footing by an exact distance of 4 1/4 inches (108 mm). Therefore, the footing plan must correspondingly reflect this difference. **NOTE:** if Taper Top forms are used in conjunction with forms that are 4 inches (102 mm) narrower in cavity width than the form below, this allowance would **NOT** be required for the design.

Always check the layout prior to placing tools and material in the work area. At most construction sites, it's usually more efficient to work from inside the perimeter walls. All materials and tools required for the assembly of the wall should be placed inside the footing area or on the slab.



FIGURE 6.03



FIGURE 6.01

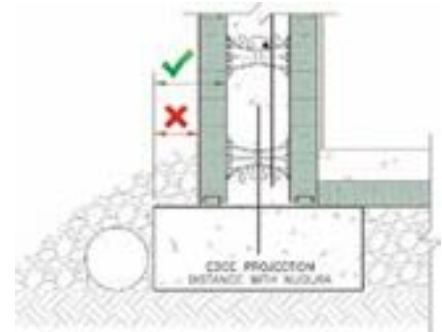

FIGURE 6.02

Special care should be taken to have form units accessible where needed while maintaining a 7' (2.13 m) clear distance around the perimeter of the walls to allow room for the alignment system installation discussed later in this chapter. Also a clean, accessible work site will prove to be beneficial both in terms of production and safety.

INSTALLATION PROCEDURES

Considerations for footing design for walls formed with NUDURA Integrated Building Technology Forms are (for the most part) no different than footings for standard poured foundation walls or concrete masonry walls. The same parameters of soil type, bearing capacity, building type, occupancy type, overall building height, floor material types, exterior finish, water table, and seismic classification obviously apply as equally to the design of NUDURA footings as they do in traditional foundation materials design.

However, the contractor should remember that the unique elements that NUDURA brings to a building site mean that there are a select number of things to consider during the structural design phase (i.e. the wall form product is composed of EPS foam, and remains part of the finished structure and that EPS foam can be readily shaped to suit site conditions when required).

Finally, vertical reinforcement dowels provide lateral support at the base of the wall. The dowels must be placed in the footing or slab edge at the center of the monolithic concrete wall. The dowels serve as a construction joint reinforcing connection and vertical wall steel does not need to be tied to these dowels. Please refer to the local building code for the area of the project to reference the on-center spacing and diameter of bar needed for this connection.



FIGURE 6.04

FOOTING TYPES (STRIP, SOG, GRADE BEAMS AND PILES, SOLID BEDROCK)

NUDURA Integrated Building Technology can be modified to create reinforced structural walls that can rest on basic strip footings, slab on grade (SOG), and grade beams connected to piles. The forms can also be scribed to bedrock.

When strip footings or slabs on grade will be used, NUDURA recommends that they be installed to within $\pm 1/4"$ (6 mm) of level. This tight tolerance in footing or slab level is one of the fundamental keys for a quality NUDURA build. Unlike conventional forming, NUDURA forms will need to be leveled following the 2nd course of form placement. By forcing the footings or slabs to be poured within the above noted tolerance, the 2nd course leveling operation can proceed efficiently with minimal need for shimming or cutting the foam to bring the form system to proper level.



FIGURE 6.05

INSTALLATION PROCEDURES

Grade Beams can be created using NUDURA Integrated Building Technology that can span across, and connect onto, piles driven into the ground. In these situations, an engineer's design is required to ensure the grade beam is reinforced to support the loads being forced upon them.

With NUDURA Integrated Building Technology, wherever a site may dictate, such as sites with steep sloping bedrock, the contractor does not need to form concrete footings to create horizontal surfaces for erection of NUDURA forms. Instead, dowels can be spiked into holes drilled into the rock (grouted as may be required) in line with the required plan profile. Then, the base of the forms can be simply "SCRIBED" and cut to the rock profile to enable seating of the form into its required position directly on top of the bedrock – a feat that is virtually IMPOSSIBLE with standard forms or concrete block. Sites like these that are normally impossible for access and convenience are easily handled using NUDURA.



FIGURE 6.06

STEP FOOTINGS

If the design will involve step footings, always remember that NUDURA forms are 18" (457 mm) in height. Therefore, to avoid unwanted waste in cutting the forms on site, installation works best if the step increments are planned in 18" (457 mm) step increments where local codes permit. This ensures that even when the forms are stacked with the lower interlock contacting the footing, the form unit extending over the step will stack smoothly and lock into position without the need of cutting off the interlocks. (Note: Consult local building codes for maximum allowable step height, and step run.)

The "shoulder", or finished locked surface, of the top or bottom of ALL of NUDURA's forms is actually located ½" (12.7 mm) above the BASE of the form when it is set on top of a footing. This gap represents the depth of each interlock tooth's projection downward below the form shoulder which is ALSO on the top of the unit ready to interlock with the course above it. As stated above, the installers will NOT cut these interlock projections off since there is no need to, as liquid concrete at a slump of 5" to 6" (125 mm to 152 mm) cannot succeed in flowing between the interlocks since the spaces are too small.

INSTALLATION PROCEDURES

If stack height planning requires starting coursing with a half height or partial height form unit, the initial step footing height **MUST** take into consideration the fact that once the form unit is cut and reversed around to interlock with the form unit above it the interlock is no longer present as part of the unit height. To ensure that the first course form shoulder occurs properly in line with the bottom shoulder of the second course, simply pre-plan that the first partial height step footing is exactly $\frac{1}{2}$ " (12.7mm) lower than the partial form cut height measured from the cut to the shoulder (or meeting surface) of the form. See Figure 6.07 for illustration of this concept.

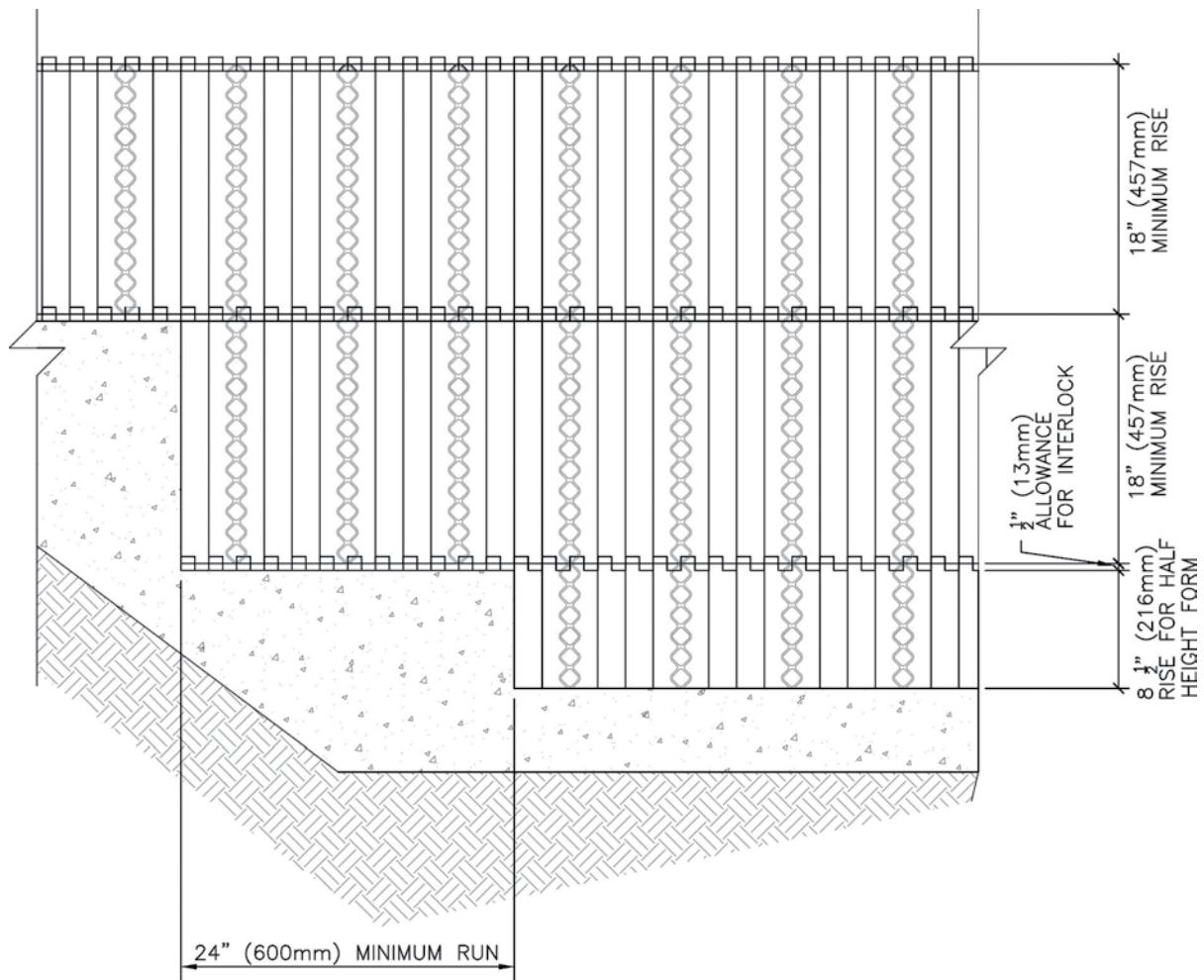

FIGURE 6.07

6.2 FIRST COURSE PLACEMENT

The footing or slab area, where the form units are to be installed, should be free of dirt and debris. Special care should be taken during the installation of the form units to keep the wall cavity free of foreign material. (This includes foam fray that will result from cutting the forms). extra time spent to establish an effective layout/pattern for the form units in the first course will save time on all the successive courses. This can prove to be a good investment of time, as it will save unnecessary cutting of form units and significantly reduce the need for form support.

NUDURA recommends starting layout on the longest wall at each corner and working towards the center. Establish a pattern around the perimeter of the building. This practice will result in any cut being close to the center of the wall. it will ensure the webs will always be lined up and locked together making it easier for the trades that will follow to attach other building materials to the fastening strips. Additionally, as stated in the introduction section, having the webs line up will virtually eliminate compression during concrete pour.



FIGURE 6.08

Ensure the form units are tight end-to-end to maintain proper dimensions. The vertical joint clips will help ensure the corner and standard forms stay tight end to end. NUDURA recommends that for the first course 8 vertical joint clips are used for both the corner and standard forms. If cuts are necessary to complete a wall length, NUDURA recommends, where possible, the form unit be cut on one of the cut lines indented in the EPS (expanded polystyrene). The cut lines must be respected to ensure the foam interlock will continue to lock with the next course of form units. When a contractor/installer cuts on the indented lines it will result in the overall building wall dimensions, having a maximum length tolerance of $\pm 1"$ (25 mm).

Important Note: If the contractor/installer needs to cut a form with more than 4" (102 mm) of EPS extending beyond the last web, additional form support will be necessary to ensure that during concrete placement these areas do not create a problem under pressure. One method is to use the 1" (25 mm) fiber tape to tape from one panel through to the other panel as shown in Figure 6.09. Care must be taken to ensure the forms are dry and free from moisture as the tape will not adhere to the foam in these conditions.



FIGURE 6.09

Alternatively, strapping can also be used to prevent bulging or problems of the EPS under concrete pressure. Simply take a short length of strapping (long enough to extend past the fastening strip on both sides of the area to be reinforced, approximately 2" (51 mm)) and screw into the fastening strips, as shown in figure 6.10. Typically 2 straps per form height will be required to give sufficient form support. This method must be performed to both sides of the form.

Special attention must be given to ensure that the building corners are square when making an adjustment to any wall dimensions. In plan layouts where dimensions are critical to local setback requirements, or specific required interior room dimensions, an "off-cut line" (vertical joint) seam is an alternate method of layout. It should be located near the center of the wall length. So long as the off-cut line seam occurs at the same point on all succeeding courses, and is supported with wood strapping or fiber tape at each course, there is no concern posed by the vertical stack joint created since the form fastening strips structurally link with each other. NUDURA experienced installers have found that cutting a 3' (914 mm) long piece of form lock and installing it into each course helps to keep the joint in line.



FIGURE 6.10

INSTALLATION PROCEDURES

Ideally, by following these rules, there should be no need to cut any corner forms and the 16" (406 mm) off-set stacking pattern that's established by reverse stacking one corner form over top another will be maintained.

Invariably, however, there will be some plan layouts where wall lengths between corners are so small that either off-cut lines or cutting the corner forms (along with "soldier stacking" of these components) will be necessary in order to complete construction of the wall. In these cases, additional form support will be required.

SPECIALTY ELEMENTS TO BE CONSIDERED AT FIRST COURSE PLACEMENT

NUDURA T WALLS

During first course placement, NUDURA's T Wall forms need to be considered in the same context that a corner form would be. Layout options should be similar to those discussed above, by starting at the corners on long walls, working towards the center and planning for insertion of a vertical stack joint where needed. Again, contractors should ensure they maintain a 16" (406 mm) vertical joint offset to best guarantee that the forms resist concrete pressure in this area. Typical areas in which a T Wall intersection might occur are unheated storage rooms, foundation wall to attached garage walls, and sunroom foundations. Additional bracing will be required to resist the increased concrete fluid pressures in this area.

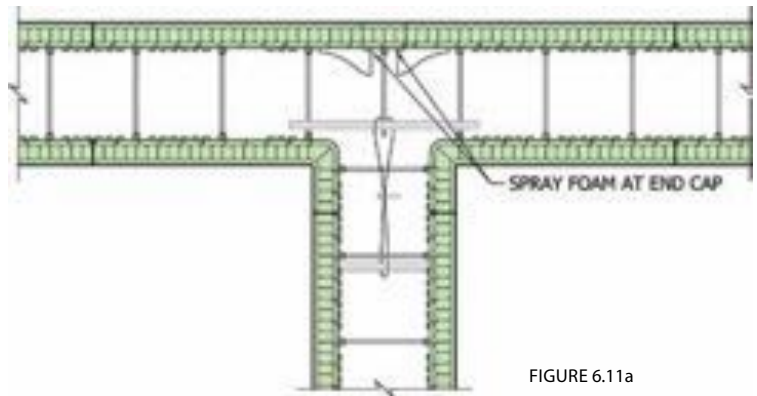

FIGURE 6.11a

NUDURA also recommends bracing the T Wall forms internally by using the following method; Place horizontal reinforcement within the main wall, extending one or two webs past each side of the T connection (See "Position A", Figure 6.11a) then cut two pieces of reinforcing steel 1" (25 mm) longer than the cavity width, inserting at either the first or second web (See "Position B", Figure 6.11b) in the T connection and tie to the reinforcing steel in the main wall.

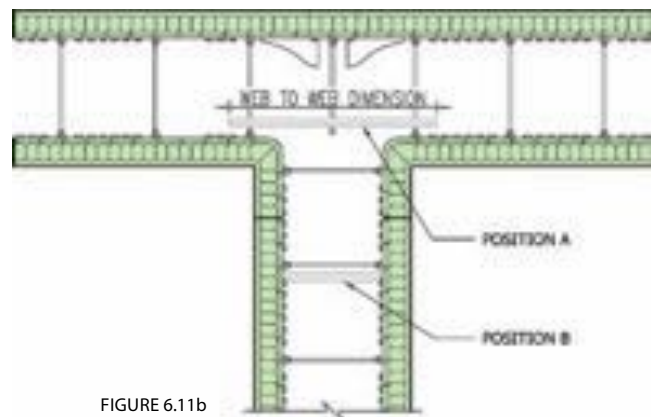

FIGURE 6.11b

Repeat this process at each successive course, but remember not to over tighten the tie wire as it might create an indentation in the main wall. The contractor/installer will not have an opportunity to release the wire embedded in the concrete once concrete has been placed within the wall cavity.

VERTICAL STACK JOINTS

Sometimes, (particularly for smaller site conditions) a plan design may dictate the need to cut the forms off the guide lines provided on the forms in order to force the final building layout to precisely conform to the floor plan. In this case, a "Vertical Stack Joint" is necessary. A vertical stack joint is completed simply by butting the forms against one another at the vertical seam up the height of the wall. Additional bracing, either internally or externally, will be required to resist concrete pressure in this area. As discussed previously, the installation of a piece of form lock ensures the wall maintains

straightness, but additional bracing can also be used to prevent separation of the forms during the concrete pour. Additional internal bracing can be as simple as taking a length of tie wire and wrapping it around the closest webs to the vertical joint, then connecting the wire to it. This procedure needs to occur at both the top and the bottom web of the form and is repeated for every course within the wall height to be constructed. Remember to not over tighten the tie wire as it can put undue pressure on the webs and creates problems during concrete placement. External bracing can be done very simply by taking scrap pieces of footing (footer) wood stakes or spreaders and screwing these to the fastening strips on either side of the vertical joint. Ultimately these pieces will need to be no longer than 16" (400 mm) and a minimum of two pieces per course will be required.

RADIUS WALLS

The same consideration for T Walls needs to be given during planning and first course placement for radius walls. The important thing at this stage of construction is to mark where the radius will start and end in its connection with the straight walls that form part of the first course. Identify from the plan, the focus of the radius and chalk it accurately onto the slab or footing, by carefully triangulating its location from adjacent straight walls and/or references from the floor plan. Next, using the radius focus, chalk the outside and inside line radii of the wall onto the strip footing or slab to the start and end point connections with the straight walls of the plan. Since these connections will typically be butt or mitered joints and will require a vertical stack joint of some type, the radius wall can be constructed independently of the rest of the build. For more details on radius walls estimating, assembly and construction, refer to the Technical Bulletin on radius Wall Construction included in Appendix F of this manual.



FIGURE 6.12

REINFORCING STEEL PLACEMENT

Steel reinforcement shall be installed as per the plans and specifications prepared by a qualified designer. The placement of the reinforcement steel shall conform to local standards, regulations or codes having jurisdiction.

Horizontal reinforcing steel should be installed into the notches (sometimes referred to as capture lugs or cradles) provided in the web, allowing for easy and secure placement. Unless specified otherwise by the designer, horizontal reinforcement is always installed after each course of form units is placed. NUDURA recommends alternating the position of the horizontal reinforcing steel from one successive course to another. This practice creates a cage that maintains the alignment of the vertical reinforcing steel which will be installed later, (see Section 6.8). Reinforcing steel is typically placed on the tension side of the wall below grade and in the center of the wall for above grade applications. Typically, the steel arrives to the site in lengths of 20 feet (6 m), which means that for almost all projects it will need to be spliced together to act as a continuous length of reinforcing steel in a wall. Except for a 4 inch (102 mm) core wall, lap splices are typically installed using "non-contact" lap splices as are provided for under most nationally adopted concrete codes. Lap splice length is typically calculated using the formula of $40D$ (40 multiplied by the diameter of wall steel specified). See Note 1.



FIGURE 6.13

INSTALLATION PROCEDURES

CHANGES IN NEW USA IRC CODES – 2009-2012

Up until the adoption of the Portland Cement Association’s ICF Prescriptive Design Document PC-100 by the international residential Code in 2009, Lap splice lengths in ICF installations throughout North America were typically calculated using the formula of 40D (40 multiplied by the diameter of wall steel specified). This rule of thumb has typically been drawn from recommended lap splice length laps in bundled steel bars as noted in BOTH the American and Canadian Concrete standards for reinforcement (See Note 1 below). However, as a result of the adoption of the PC-100 document, the following NEW sections were added to the 2009 and 2012 versions of the IRC.

R404.1.2.3.7.5 Lap splices. Vertical and horizontal wall reinforcement shall be the longest length practical. Where splices are necessary in reinforcement, the length of lap splice shall be in accordance with Table

R611.5.4.(1) and Figure R611.5.4(1). The maximum gap between non contact parallel bars at a lap splice shall not exceed the smaller of one-fifth the required lap length and 6” (152mm). See Figure R611.5.4(1)

What DOES become evident is that in fact 60,000 psi (420 Mpa) steel (the minimum grade specified in NUDURA’s Structural tables) in fact NOW requires a 60d lap splice. See Table R611.5.4(1) below:

**TABLE R611.5.4(1)
LAP SPLICE AND TENSION DEVELOPMENT LENGTHS**

	BAR SIZE NO.	YIELD STRENGTH OF STEEL, f_y psi (MPa)	
		40,000 (280)	60,000 (420)
		Splice length or tension development length (inches)	
Lap splice length-tension	4	20	30
	5	25	38
	6	30	45
Tension development length for straight bar	4	15	23
	5	19	28
	6	23	34
Tension development length for: a. 90-degree and 180-degree standard hooks with not less than 2 1/2 inches of side perpendicular to plane of hook and b. 90-degree standard hooks with not less than 2 inches of cover on the bar extension beyond the hook.	4	6	9
	5	7	11
	6	8	13
Tension development length for bar with 90-degree or 180-degree standard hook having less cover than required above.	4	8	12
	5	10	15
	6	12	18

For SI: 1 inch = 25.4mm.

CANADIAN CODES

Applying the same rules from the above IRC Code Change under Canadian jurisdiction will change slightly due to Canada’s different metric bar diameters.

For example, let’s suppose a wall needs 10M bar (actual size 11.3 mm diameter) horizontal reinforcing steel. The contractor or installer simply needs to calculate the lap length by multiplying $60 \times 11.3 \text{ mm} = 678 \text{ mm}$ (or about 27”). Therefore, each horizontal reinforcing steel bar should overlap the other by 678 mm or about 27”. (Note that the conversion factors for metric in Canada are different from the US based values because of the differences in steel diameters given).

PERMITTED SEPARATION OF NON-CONTACT LAP SPLICE LENGTHS

There are two types of lap splices: Contact lap splices (which means the reinforcing steel is touching and needs to be tied), and non-contact lap splices (which means the reinforcing steel can be separated up to 1/5th of the lap length to a maximum of 6” (150 mm) and does not need to be tied). using the example above, the separation of the 2 pieces of reinforcing steel would be calculated using the formula 1/5th of the lap length. (See Note 2).

Note: 1: Reference: ACI-318-08 Section 7.6.6.4 / CAN/CSA A23.3-04 Section 7.4.2.3

Note: 2: Reference: ACI-318 Section 12.14.2.3 / CAN/CSA A23.3-04 Section 12.14.2.3

6.3 SECOND COURSE PLACEMENT AND LEVELING

NUDURA recommends that the contractor/installer start the second course at the same corner as the first course, following the same steps of working from each corner towards the center of the wall. When placing the second course corner forms, each corner form unit will be reversed to create an automatic 16" (406 mm) offset or "bond" stack with the form units on the first course. Again, remember to align the units in place and press the form unit firmly downward until the web interlocks "snap-lock" together. After the form unit is in place, as mentioned in Chapter 3 (Tools), a rubber mallet can be used to ensure that the interlocks are properly seated tightly together.

Additionally, NUDURA recommends that in the corners, 4 vertical joint clips are snapped into place locking the corner to the adjacent standard form. Although, as stated earlier, 16" (406 mm) is the ideal offset (as established by the corner forms), a minimum of 8" (203 mm) staggering of vertical joints should be maintained between courses to ensure that the interlock mechanisms on the end of each web will secure the forms tightly together. Should a vertical joint be less than 8" (203 mm), the contractor/installer will need to add additional form support. This can consist of sheathing or 1" x 4" (19 mm x 89 mm) lumber attached to the fastening strips using #10 x 2" (51 mm) wood screws.

Once the second course of forms has been locked into the first course, the horizontal reinforcing steel will, once again, need to be placed within the webs. Remember to offset the bar location by 1 notch (from the corresponding bar in the course below) to ensure the vertical steel can be easily woven between the horizontal steel bars. Additional to the reinforcing steel being placed within the forms, NUDURA strongly recommends that a row of form lock now be placed within the cavity of the wall to maintain straightness. Refer to Chapter 5 for installation instructions of the form lock.



FIGURE 6.14

Once the second course has been completed, the forms will need to be leveled to account for any uneven areas of the footings or slab. Although the footing/slab can be checked prior to installation of form units, the best method is to correct any deficiencies after the first 2 courses of NUDURA form units are installed.



FIGURE 6.15

The forms will bridge over low areas of the footing and ride on the high points. A laser or builder's level can be used to easily set elevations, ensuring the walls finish at the desired elevations. It is easier to fill in hollow or low areas under the form than to cut the form where footings are high. Usually, the fix for uneven footings will require both shimming and cutting.

Upon completion of leveling the forms, the contractor/installer can either foam the forms to the footing (footer) or slab or install form/guide boards. NUDURA recommends using the low expansion spray foam as the method of securing the forms to the footing (footer). This will not delay the contractor/installer from continuing with additional form placement for the project, as the spray foam sets within 15 minutes of placement. Also, upon completion of pouring concrete in the forms, no additional time will be required to remove this material before backfilling occurs. NUDURA's low expansion spray foam will be completely cured after 24 hours.

6.4 ADDITIONAL COURSE PLACEMENT

As discussed in Sections 6.2 & 6.3, the layout of the first 2 courses of form units are extremely critical as these set the benchmark for all additional courses above. The contractor/installer can now simply follow the pattern established within the first 2 completed courses of forms. For example, the first, third, and fifth courses, or all odd numbered courses, should be stacked identically. This includes all form cuts, rebar placement and splice laps. The same placement method is followed for the second, fourth and sixth courses, or all even numbered courses. If vertical stack joints are present within the wall length, these will need to be maintained up the entire height of the wall. The only areas that will need some modifications are around the openings and possibly service penetrations. These will be discussed in Sections 6.5 & 6.7.



FIGURE 6.16

Additional form support may be required to prevent movement of the forms during concrete placement as covered in Section 6.2. The following conditions may also require additional support:

- If there is more than 4" (102 mm) extending beyond the web at a cut end
- Minimum 8" (203 mm) vertical offset is not achieved, or cut is next to a corner
- T-walls on the main wall side to resist concrete pressure
- Tapered Top form needs additional reinforcing on the top edge of the tapered side
- Window or door openings near a corner

All of these situations will need additional form support to ensure movement does not occur during concrete placement. Again, fiber tape, strapping, or strips of sheathing will work in these difficult areas.

6.5 OPENINGS

Window and door openings can be easily created within NUDURA'S forms using a number of different buck materials to frame and hold back the fluid concrete until curing has occurred. These methods can include lumber material (pressure treated or wrapped plain lumber), EPS end caps with lumber material for the header, vinyl bucks, steel bucks, or with the NUDURA Easy Buck (a composite buck system using lumber inserts).

The Rough Opening (RO) dimension is the opening required to install the window or door, allowing for adjustment and additional insulation at the time of installation. It is important to establish if the type of buck being used is "stay-in-place" or to be removed prior to the installation of the window or door.

The RO in a "stay-in-place" buck will be the interior dimension of the buck. Remember to allow for the thickness of the buck material being used.

Wood bucks can be constructed using 1" (19 mm) or 2" (38 mm) dimensional lumber which is the same width as the overall wall thickness (including EPS insulation).

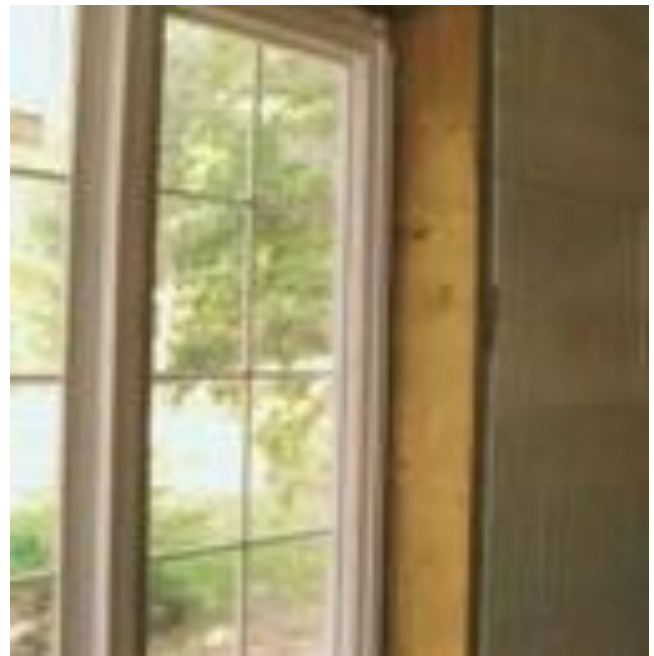

FIGURE 6.17

Wood bucks can also be created by inserting cut or widened lumber in the cavity of the form to create the required opening. It can be secured in place with expanding foam sealant and temporarily cross braced until concrete has cured.

The buck can also be built using the easy Buck material as a “stay-in-place” buck. The method consists of a combination of the easy Buck and dimensional lumber. When anchoring the easy Buck to the wood, NUDURA recommends the contractor/installer use #10 (metric version) 4”-5” (101 mm - 127 mm) long screws, and screw through the easy Buck into the wood, extending the screw to the inside of the form cavity. By extending the screw through the wood material and having it exposed to the cavity area of the form, once concrete is cast into the wall it acts as an anchor point for the buck material to be connected to the concrete wall. This ensures that the buck material will not move once the windows/doors are installed.

Another method is to create wood bucks that are 2 5/8” (67 mm) smaller than the overall form depth and utilize the NUDURA Easy Buck on one side of the wall. This allows interior finishes to be fastened directly to the wood material, but also creates a thermal break through the forms. One caution to using the Easy Buck system for the outside, is that should the exterior finish be specified as a stucco material, the easy Buck must be removed (by cutting the outer plastic capture fins away) to allow proper bonding of the stucco to the EPS.

Bucks can also be created using NUDURA end caps with fastening strips. The head of the buck is usually created with lumber in a similar fashion as for the wood buck. If greater depth is required for the concrete lintel, the buck should be constructed to allow for the removal of the lumber used in the head of the buck. This will result in a concrete lintel 1 1/2” (38 mm) deeper.

When constructing the bucks that will be used for the openings, the sill areas need to be left open to allow for concrete placement. One option would be to use 2” x 2” (38 mm x 38 mm) or 2” x 4” (38 mm x 89 mm) lumber for the sill of a window buck. This allows access for the contractor/installer to completely fill the area below the window with concrete and also screed it smooth. Another option would be to use a solid piece of buck material and cut access holes to ensure concrete completely fills these areas. Whether the buck material stays in place or is removed will be a decision for the contractor/installer, but having access to this area



FIGURE 6.18



FIGURE 6.19

INSTALLATION PROCEDURES

will allow different finishing options to be used. Concrete finishing options include finishing the concrete flush with the top of the buck material, or finishing the concrete flush with the top of the forms and remove the buck material used for the sill area of the opening. Pressure treated lumber may be required in certain applications as per local code requirements, and should be wrapped on the back side of the lumber material with a minimum of 6 mil poly to ensure the wood does not come into contact with the concrete. When the buck material is designed to stay in place and the window or door is to be fastened to it, it is important to provide proper anchorage of the buck to the concrete as per code requirement.

Prior to the concrete placement, all required means of form support must be installed to resist fluid concrete pressures. Any corners of 8' (2.44 meters) or less from an opening will require form support, tying the corner back to the buck. Alternately, exterior bracing could be installed to provide support to the corner forms.

LINTEL REINFORCEMENT

As covered already in Section 2.1.2, lintel reinforcement requirements will vary based on the loading conditions, depth of lintel, width of opening, concrete strength, and wall thickness. NUDURA® Inc. has prepared engineered Lintel Tables for NUDURA walls that can be used for submission to the building department as well as in the building process in field. These lintel tables are designed for a concrete strength of 3000 psi (20 MPa) and are included within this manual under Appendix E.

If your project drawings have been produced using NUDURA's installation Manual as outlined under Chapter 2, then you can proceed straight to installation of the required lintel steel per either the specifications on your drawings or on the lintel schedule that would be attached to the drawings. If not, please refer to Chapter 2 for details on how to use the lintel tables and to calculate the required uniformly distributed loads for the project.

Refer to Figure 6.20 which is a diagram of a typical opening that shows the different reinforcing pieces and where they must be placed in order to correctly install lintel steel. This diagram has been taken from the page preceding the lintel tables in Appendix e and shows the key items that must be completed to ensure proper placement of the reinforcing steel has occurred. This also allows the contractor/installer to understand what key items need to be extracted from the tables for construction of the lintel.

Additional to the lintel steel, you'll also see that the diagram requires 2 - #4 (10M) bars to be placed vertically on either side of the opening and 2 - #4 (10M) bars placed horizontally at the sill location of the opening extending 24" (610 mm) into the solid wall.

TOP STEEL PLACEMENT

If using the lintel tables within this manual, the top reinforcing steel will always be 1- #4 (10M). This piece of steel will extend 24" (610 mm) past each side of the opening into the solid wall and be placed in the center of the wall cavity. The contractor/installer must ensure that during concrete placement the pour needs to terminate 1 ½" (38 mm) above the top reinforcing steel.

The top steel can be installed in one of 2 ways.

- (a) Clip the top steel in position on the reinforcement steel notches on the top of the form webs that are located at, or very near, the required top steel position within the lintel height. This would be automatic if your coursing height works out to be in line with the designated finished top limit (including concrete cover) of the lintelor...
- (b) Hang the steel at the exact required position using 3 (or more) tie wires to suspend it at the correct height within the lintel area from the closest horizontal reinforcement bar above it. This will likely be required if the course heights in the wall do NOT line-up with the designated top of the lintel.

INSTALLATION PROCEDURES

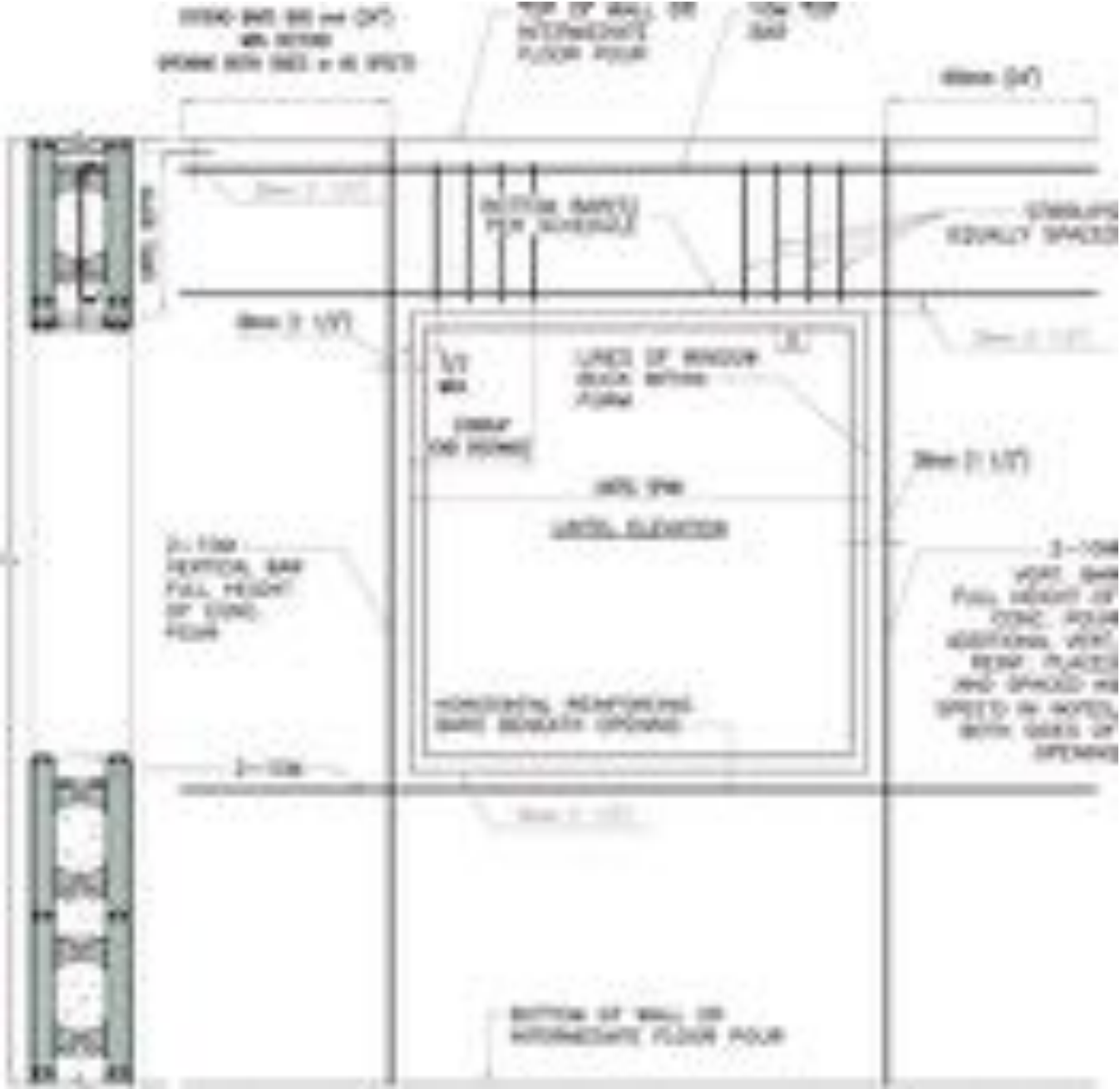

FIGURE 6.20

INSTALLATION PROCEDURES

BOTTOM STEEL PREPS

The bottom reinforcing steel will be determined through the tables based upon loads, opening width, and depth of concrete. It too must remain in the center of the wall cavity and extend 24" (610 mm) into the solid wall on BOTH SIDES of the opening. Again, the bottom reinforcing steel must be encased with a minimum/maximum 1 ½" (38 mm) of concrete coverage.

As per specification from the tables or lintel schedule, if the bottom steel is a single bar, cut it to the required length and set the bar in position on top of the window buck, which the lintel will be supporting over. If the bar is to be bundled, tie wire the bars together with 2 or more ties to ensure they react as a single unit.

If the bottom of the top of the buck will be beyond reach of the top of the form unit in which the lintel is being assembled, position 2 or more lift wires (again using tie wire) under the bar to help assist lifting the bar into position. If NO stirrups will be required, you can use these tie wires to properly suspend the bar at its required height.

SHEAR STIRRUPS AND FINAL BOTTOM STEEL PLACEMENT

Per Section 2 of the manual, the stirrup end distance obtained from the tables (or your drawing lintel schedule) is the distance from the edge of EACH SIDE of the opening to where the first stirrup will be placed near the center of the opening. (Refer to Figure 6.20) The stirrup spacing is also determined within the tables and starts from the specified stirrup end distance. The stirrups will then be suspended at regular centers from the top steel bar at the specified spacing requirement, working from the center of the opening towards the solid wall on either side of the opening. Should the distance between the last stirrup and the solid wall be more than ½ of the stirrup spacing required, an additional stirrup will need to be installed. The last stirrup will be placed using the stirrup spacing required and may result in the stirrup being located past the edge of the opening in the solid wall. For example, if the stirrup spacing was 10" (254 mm) and the distance to the solid wall was 6" (152 mm) (more than half of the spacing) then an additional stirrup is required. In this example, the final stirrup will be located 4" (102 mm) into the solid wall past the edge of the opening.

Once the shear stirrups are in place, the final step will be to hoist the bottom steel bar, single or bundled, into finished position to properly cradle the steel into the bottom curls of the shear stirrups. On longer lintels, 2 workers may be required to pull the bar into position.

SPECIAL CONDITIONS AT OPENINGS

This section discusses special issues that may arise with respect to wall openings including:

- Radius Topped Windows or entrance Frames
- Bow or Bay Window Conditions
- Corner Windows

Radius Topped Openings: radius topped windows or entrance frames can be easily accommodated with NUDURA using one of several options for assembly. The only substantial difference from standard windows is that the lintel steel spans the full opening (regardless of the radius width), treating the very top of the radius portion of the opening as the BOTTOM of the lintel itself.

One option is to construct the opening bucks with curved plywood inserts to suit the required framing opening and shim clearance. The wall area over the opening is then assembled using NUDURA panels and insert webs that are cut and assembled to suit the curve of the plywood buck materials and inserts. As with traditional openings, the radius plywood inserts will require temporary support to be installed below, within the rectangular portion of the opening.

An alternate method is to build the wall as normal, using standard NUDURA forms, around the square part of the opening to the start of the curved portion of the radius but at the start of the radius (as with the plywood insert option) revert to NUDURA panels and insert webs, and assemble them straight across the opening. The opening buck below should be assembled rectangularly, ignoring the curved portion being installed above it.

INSTALLATION PROCEDURES

Next, cut multiple foam sheets, sufficient to suit the wall cavity thickness to the exact radius profile required for the anticipated window or entrance frame and shim clearance. Be sure to use these as a drawing guide to trace the radius outline on the outside foam surface on both sides of the wall. Then glue the foam panels in place in the cavity over the rectangular opening buck.

Cut and assemble the required insert webs over the radius cut foam billet that is filling the cavity.

Install the lintel steel as specified above.

Once the concrete is cured and the buck supports are ready for removal, simply follow the guidelines to cut the foam tight to the concrete. The result will be a perfectly curved concrete radius ready to suit the window or entrance frame specified.

A third option is to build the wall as normal with NUDURA panels and insert webs, again ignoring the curved portion of the opening, but constructing the wall above the standard portion as follows:

1. Trace the required radius top over the opening using the desired frame and shim clearance pattern on both the inside and outside of the wall forms installed above the opening.
2. Using a keyhole saw or jig saw, carefully cut the foam panels and web materials on either side of the wall, but retain these materials for immediate re-use. Be sure to examine the cut webs and insert new inserts or height adjuster ties as necessary to reinforce the panels as required where the curved line meets the opening. Repeat this for the web materials that link the panel areas that were cut.
3. Next, using aluminum sheet cut to the overall form depth, wrap the complete radius with the sheet material and tape it temporarily in position with fiber tape.
4. Finally, restore the cut portion of NUDURA form work into the position where it was cut out and tape into position, in effect sandwiching the curved metal sheet between the insulation panels along the cut line. Provide buck support below and complete the concrete pour.
5. When the buck supports are removed, simply remove the insulation panel and metal sheet.

Bay Windows, Bow Windows and Openings Near Corners: Questions often arise as to how to handle lintel construction associated with these types of openings. The same methodology applied to straight run window lintel construction should also be applied in these situations, but bending the top and bottom steel to suit the wall's turn in axis. Be sure to adhere to the requirements for extension of both top and bottom steel, even if it means bending the steel around any corner condition occurring near the opening.

A structural engineer may need to be consulted for specifying reinforcement above bay window conditions, even those that are separated by corner mullions. It is likely that the engineer will treat the area as a single opening of width equal to the combined length of the 3 window segments. The lintel steel should be installed accordingly even if there will be steel post supports at the bay window corners.

NOTE: Current Canadian Prescriptive Code requirements under Sections 9.17.3 and 9.17.4 prohibit occurrence of openings within 4 feet (1.22 meters) of a corner. This requirement is often impractical when applied to most building plans of smaller size. If movement of an opening away from such a corner to resolve the issue is not practical. In the vast majority of jurisdictions across Canada, most municipalities will enable adoption of all of NUDURA's Stamped Prescriptive Data as listed in Appendix D and e including Notes 36 and 37 as these pertain to required solid wall lengths between window openings. By allowing use of the solid wall length design table provided under these notes, the limiting requirements of Sections 9.17.3 and 9.17.4 may be avoided provided the local approving official is willing to accept this data as part of the submitted design.

However, in the event that a municipality should refuse consideration of the design data provided above, it again may be necessary to consult a structural engineer to review such conditions and provide documentation to waive the requirement for compliance to these clauses. Consult NUDURA Technical Services through your local Distributor for assistance in this issue if you are unsure.

6.6 NUDURA ALIGNMENT SYSTEM

A key element of NUDURA's product lineup is the NUDURA Wall Alignment System. This system is a multi-purpose set of components aimed at ensuring the forming system has support during concrete placement, while also providing a safe working platform for the contractor/installer. As with any scaffold system, safety must always be monitored on the project. The contractor/installer needs to be aware of, and understand, all safety codes and regulations with respect to spacing, planking, and safety rails. The alignment system has been designed to support the weight of the workers, wind loads, and the weight of the wall only. Should the alignment system be used for things other than what it has been designed for, it may result in failure and possibly bodily harm to the workers using the system.

NUDURA's alignment system has been tested to meet all safety standards for North America, and most European Countries. Should a safety authority request documentation regarding the alignment system and its conformance to the local safety code, this is available through the local distributor for the contractor's/installer's area. Should the use of the alignment system fall outside of the general safety code conformance, site specific engineering will be required.

The alignment system is made up of the following components:

Diagram	Part Name	Part Number	Number of Pieces
A	Turnbuckle (top & Bottom)	TBUKL	20 of each
B	Base Plate	BPLATE	20
C	Catwalk Bracket	CATBRA	20
D	Guard Rail Post	GRAIL	20
E	3/8" x 2 1/2" Lock Pin (9.5mm x 63.5mm)	D-CLIP	40
F	5/8" x 3" Bolt & Locking Nut (16mm x 76mm)	—	20
G	1/2" (13mm) Gravity Pin	G-PINS	40
H	8' (2.438m) Box Channel	CHA-8	20
H	10' (3.048m) Box Channel	CHA-10	20
H	12' (3.658m) Box Channel	CHA-12	20

* The bracing components are crated and include the following items (BRAC-L); Turnbuckles (assembled with foot plates), Catwalk Brackets, guard rail Posts, Lock Pins, and gravity Pins. Box Channels are a separate crate.

INSTALLATION PROCEDURES



FIGURE 6.21

In addition to the alignment system components, NUDURA offers a steel crate that will neatly contain 20 complete sets of the bracing including the box channels.

ALIGNMENT SYSTEM INSTALLATION

1. There are a few things that the contractor/installer should check on the alignment system to ensure it is in good working order before assembling the components onto the wall.
 - (a) Check each component to ensure none of the pieces are bent, cracked, or worn out. Should the contractor/installer notice any pieces that pose any type of safety risk, the pieces need to be removed from the set and excluded from use on the wall.
 - (b) Ensure the threads on the turnbuckle move freely for the full length of the threads.
 - (c) Should it become difficult to turn the threads, a light grade lubricant or general purpose grease needs to be applied onto the threads.
2. The NUDURA alignment system will only need to be placed on the one side of the NUDURA forms, preferably on the inside perimeter of the building. The alignment system will need to be laid out on the wall at 5'- 4" (1.63 m) on center spacing. This will allow for proper plank spacing, as well as sufficient overlap. Remember that when laying out the spacing of the box channels the contractor/installer should also take into consideration the floor joist layout and connection method. The box channel layout may conflict with these embeds and might need to be adjusted. Also, remember to add additional braces on either side of openings. Depending upon the size of the openings, one brace may have to be placed within the center of the opening.
3. Once the layout has been completed, the contractor/installer will need to attach the box channel (closed end (base) at their feet) to the wall. Within the NUDURA form system, every 8" (203mm) on center there are 1 1/2" (38mm) wide fastening strips located 5/8" (16mm) below the surface of the EPS foam. These are marked with a diamond shaped pattern running vertically along the form. Place the box channel up against the form, remembering to line up the outside edge of the channel with the first cut line on either side of the fastening strips. This will ensure that the box channel stays plumb the entire height of the wall.



FIGURE 6.22

INSTALLATION PROCEDURES

- Next take a #10 cut screw (NUDURA Hex head screw w/steel flat washer SC-2.0), placed close to the top of the slots at the back of the box channels and using a cordless screw gun, drive the screw into the fastening strip (Figure 6.23). remember to not over tighten the screw as the forms need to be able to slide vertically within the slot on the box channel to allow in the ease of straightening. One screw per course is necessary up the entire height of the wall. Also, the base of the box channel can now be mechanically fastened to the base it is resting upon.
- Next, connect the adjustable diagonal pole brace to the box channel using the ½" (13 mm) diameter gravity pin, as shown in Figure 6.24, and anchor the diagonal foot pad base to the ground or floor with either drift pins or a #10 cut screw (NUDURA Hex head screw w/steel flat washer SC-2.0).

Contractors/installers are responsible for the holding capabilities of the drift pins/fasteners used to anchor the diagonal foot pad base. Also, remember that different lengths of drift pins will be required based upon soil type.

- Once the diagonal foot pad base has been securely fastened, connect the catwalk bracket onto the adjustable diagonal pole brace. Take the catwalk bracket and place it, engaging the hook end of the catwalk platform overtop of the adjustable diagonal pole brace and gravity pin connection.
- Take the second ½" (13 mm) gravity pin and install it through the box channel and bottom leg of the catwalk bracket, securing it together. (Figure 6.25)
- Finally, the guard rail post can be attached to the catwalk bracket. Simply slide the guard rail post into the catwalk bracket stub and secure it together using the ⅜" x 2 ½" (9.5 mm x 63.5 mm) lock pin (Figure 6.26). Now, add the necessary wood rails and toe kick rails as required, along with the proper scaffold planking, remembering to have the necessary overlap as needed.

The alignment system must stay attached to the walls until sufficient concrete curing has occurred. Should the contractor/installer elect to remove the alignment system before the concrete has had sufficient curing time, temporary bracing will need to be installed. Alternatively, the contractor/installer may install the floor or roof system to provide lateral support before removing the alignment system.

IMPORTANT! In below grade applications, backfilling should not occur until sufficient concrete cure has been achieved and the sub-floor has been installed to provide lateral support against backfill pressure. Remember that concrete will achieve approximately 40% of its design strength within 3 days, 60% within 7 days, and concrete will achieve its full compressive design strength at 28 days.

Once the alignment system has been removed from the wall, remember to return the adjustable diagonal pole brace threads to the center position (approximately 6" (152 mm) of thread exposed). Also remove any concrete residue from all components of the alignment system before storage or transporting to the next project.



FIGURE 6.23



FIGURE 6.24



FIGURE 6.25



FIGURE 6.26

6.7 SERVICE PENETRATIONS

As with all installation procedures, pre-planning of the service penetrations will ensure that when the time comes to install each service, additional labor is not incurred. Most penetrations that are necessary for a building require the contractor/installer to cut out a piece of the EPS and insert the required size of material for that service to run through. It is NUDURA's recommendation to contact the appropriate sub-trade for the proper size and location of the sleeve.

Below is a list of common service penetrations that may include some or all of the following items for a project;

Water supply	Hot water tank vent
Sewer or septic pipes	Exhaust fan vent
Storm sewer line	Range hood vent
Electrical service	Dryer vent
Oil filler and vent	HRV vents
Natural Gas or Propane line	A/C lines
Gas Fireplace exhaust vent	Air Exchanger
Exterior electrical fixtures and receptacles	Furnace exhaust vents
Audio & video service	Hose bibs
Spares	

Installation of service penetrations is a simple procedure; the contractor/installer will need to cut a hole in the EPS using a keyhole or pruning saw for the sleeve as required. When laying out the locations of the sleeves, should a service penetration be located in the middle of a web, it is recommended to move the sleeve to one side or the other to eliminate the need to cut the web, which will weaken the form. Additional form support around the opening will be required, should it be necessary to cut a portion of the web in order to fit a sleeve into the desired location. If the required sleeve size is larger than 16" x 16" (406 mm x 406 mm), then it will be necessary to add additional reinforcing steel.

Be sure to use the correct size of conduit to suit each service penetration individually. The contractor/installer should make sure the conduit extends through the wall long enough to permit the use of couplers or fittings at each end. This ensures when the sub-trade has to perform their tasks, the EPS foam around the sleeve will not need to be removed to attach the couplers.

For dryer ducts or other more flexible sleeves, consider fitting the cut plugs of EPS inside the sleeve to provide additional support to the concrete during placement. These can be removed later after the concrete is cured as part of the installer's final strip and clean-up.



FIGURE 6.27

Wherever possible, coordinate with the general contractor or the various sub trades for determining any specific requirements that each trade may have (i.e. location, or, as in the case of plumbing fittings, elevation and required slope of the sleeves) prior to installation.

6.8 VERTICAL REINFORCING STEEL PLACEMENT

Once the desired height of the wall has been reached, and before concrete is placed within the wall cavity, a final row of form lock, as well as the vertical reinforcing steel, should be placed into the wall.

The form lock should be installed first as it needs to be force fitted in between the EPS panels as previously discussed. Once the form lock has been completed, the contractor/installer can now install the specified vertical reinforcing steel. The vertical steel sizes and spacing can be found at the back of this manual in Appendix d. The contractor/installer will need to know if the project falls in a seismic zone, and what the wind loading conditions are for the area. This information can be obtained either by consulting your local applicable building code, or consulting the building department for the municipality where your building project is located.

Alternatively, reinforcing steel can also be determined from the local building code, which again will require the contractor/installer to know what elements the project will fall under for steel sizes and spacing.

Once the vertical steel has been determined, simply start at the corner that has been designated as the starting point for concrete placement and weave the vertical steel between the horizontal steel. This will lock the vertical steel into place and prevent it from moving side to side within the wall cavity. Continue to slide the steel into the cavity at the specified center spacing around the perimeter of the project.

In most of NUDURA's forms, if the vertical steel specified is below no. 5 (15M) in diameter, the horizontal dowels may not fully capture the steel solidly enough to prevent it from moving in the longitudinal direction of the wall axis. In this case, the vertical steel can simply be placed against the webs that are already vertically aligned in the wall. The installer then allows the concrete to push the bar against the web during placement. This will ensure the vertical steel is exactly vertical during placement and that it won't move out of position.

The top of the vertical reinforcing steel will terminate, as specified below, at the top of the forms. Should additional storeys of NUDURA be needed, wet setting the dowels are recommended over having the vertical steel extend above the last form. An alternative method to wet setting dowels is to install another course of the forms using these forms as a funnel for concrete placement. Remember to terminate the concrete below the top of the forms of the specified lap splice distance as required for the reinforcing steel being used.

After all the form units are installed, and prior to the placement of concrete, the vertical reinforcing steel should be terminated as specified below the top of the wall. If successive storeys are to follow, construction joint reinforcement dowels should be installed as per the vertical reinforcing steel placement.

Field experience has proven it is easier to insert joint reinforcement dowels after the concrete placement versus working with longer, vertical reinforcing steel which can interfere with the concrete placement within the forms.



FIGURE 6.28

6.9 SPECIAL APPLICATIONS

FLOOR CONNECTIONS

Before concrete is placed into the forms, some additional steps need to be considered, dependant upon what stage of construction the project is currently under. If the current stage is the foundation with additional stories to follow, the attachment of a floor will have to now be considered. Note: see detail C-4 in Appendix c of this manual for typical floor connector details. This is essential because in most residential structures these floors are still wood joists with plywood sheathing. Should the floor connection be something other than light framed wood floors, an engineer's design will be necessary for the reinforcing required in the walls. This method of floor connection does need to be pre-planned before concrete is poured into the forms. First the contractor/installer needs to decide what method will be used for hanging the floor from the concrete wall. There are several methods for connection of the floor joists to the concrete wall that include the following;

- ICF Hanger System
- Simpson Strong-Tie (ICFVL™)
- Simple Anchor bolt
- Modified Anchor Bolt with Moment Connection Plate
- Ledge Support.

ICF Hanger System: The ICF Hanger System is probably one of the fastest and easiest methods for floor attachment with the least amount of additional labor. A technical bulletin on detailed installation of this system can be found in Appendix F of this manual.



FIGURE 6.30



FIGURE 6.29

Simpson Strong Tie ICFVL™: Like the ICF Hanger System, the Simpson Strong Tie ICFVL™ System connection requires the embedment of a galvanized plate through the foam into the concrete. This will additionally require a ledger board to be attached to the embedment, along with shear connection J Brackets at each embedment, and joist hangers for the floor members to rest into. For the full installation, and recommended spacing, please refer to Simpson Strong-Ties web site.

Simple Anchor Bolt: Although more labor intensive than any other method, one connection method that has the added advantage of being approved under most current prescriptive building codes throughout North America (without the requirement of separate engineering tables) is the use of horizontal embedded anchor bolts. Again, a ledger board and joist hangers are required. This method will require the removal of some EPS foam to allow the concrete to flow out flush with the face of the form. Once the concrete has been placed and partially cured, simply remove the temporary form, drill and attach the ledger board, and connect the joist hangers as required for the floor joist spacing. One thing to note is how the EPS has been cut in the form. These cuts ensure that during concrete placement voids will not occur in this area. Proper consolidation of the concrete will also ensure the pocket becomes encased with concrete. Please refer to proper concrete consolidation techniques in section 6.10.

INSTALLATION PROCEDURES

Modified Anchor Bolt with Moment Connection Plate: Some manufacturers also distribute modified anchor bolts which contain a welded square plate in line with the I shaped bend of the anchor bolt. The plate is designed to the same thickness of the NUDURA EPS panel. These special bolts are engineered to handle the bending moment condition that is typically created because of the extension of bolt beyond the concrete surface. The plate enables transfer of the vertical loads laterally into the face of the concrete. As with simple anchor bolts, this system Also requires floor support ledgers and joist hangers. However, the big plus with this system is that the bolts can be pre-installed into the foam with very simple horizontal slit cuts as opposed to having to remove full foam segments making them much less labor intensive to install. Be sure to check with the manufacturer for any supporting engineering documentation for this option.

Ledge Support: A ledge can also be created by using forms of different widths as shown in Figure 6.31. By using NUDURA taper top forms as the ledge for the floor joist to rest on, and connecting a smaller width form to the tapered top (using the NUDURA Form transition bracket Accessory), a ledge is created. The smaller width form must be able to create a ledge that, by code, will allow enough end bearing to support the joist. By most codes 1 1/2" (38 mm). this method can incorporate the use of bottom chord load bearing floor joist and also top chord load bearing floor joist.



FIGURE 6.31

BEAM POCKETS

Beam pockets are another very important structural element that need to be planned for before any concrete is placed within the forms. Beam pockets can be placed anywhere along the length of a NUDURA wall. Again, the floor plans will provide the contractor/installer with the exact location of the beam placement to carry the required members to the solid wall. Additional vertical reinforcing steel may be required at these locations to ensure the loads are transferred correctly throughout the wall section. Please refer to Appendix d of this manual for the number and size of reinforcing steel bars required for these areas. If the contractor/installer is referring to alternate design information, check within the appropriate areas pertaining to beam pocket reinforcing. The contractor will need to check all measurements to ensure the pocket is in the correct location to receive the beam at a later part of the construction process.



FIGURE 6.32

One method for creating a pocket is to use 2 of NUDURA's end caps and slide them into the cavity of the wall for the location of the beam (smooth sides facing the concrete). the contractor/installer needs to make sure there is access to screed the bottom of the pocket flat to help reduce the number of shims required for the beam to rest on. The detail on the right demonstrates how the end caps are slid into place along with cutting open an area to allow the contractor/installer an opportunity to screed the bottom of the pocket smooth. Once the concrete has been cast into place and cured, the contractor/installer will simply cut out the EPS and remove it from the pocket area. The beam is then installed similar to typical construction practices.

INSTALLATION PROCEDURES

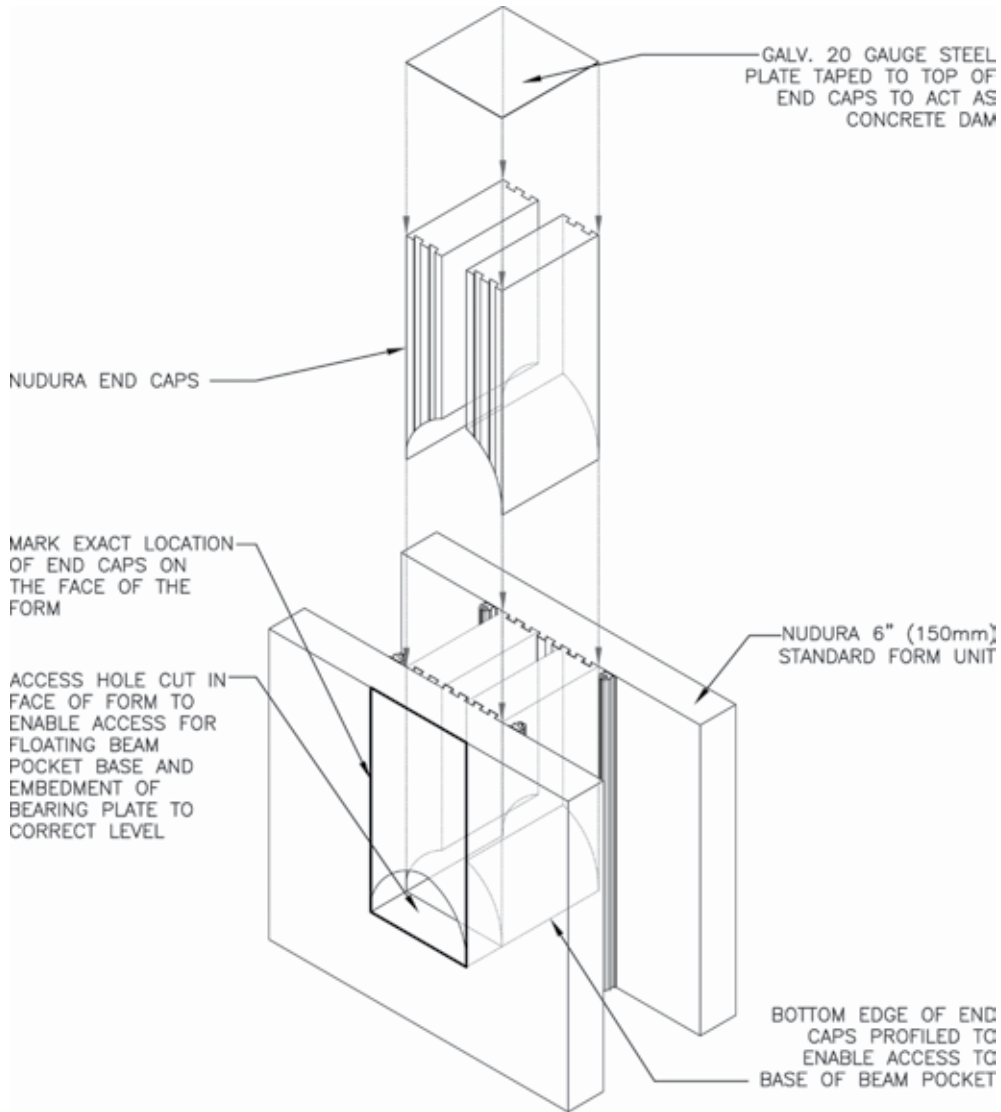

FIGURE 6.33

Another method is to take a piece of EPS foam and cut it to the desired dimensions, then spray foam this to the inside of the panel on the side of the wall that the beam will rest onto. As stated above, access to the bottom of the pocket will allow the contractor/installer the opportunity to screed this area smooth for the beam to rest on later. (Bearing or weld plates can also be taped in place to the bottom of the foam if desired, though care must be taken to adequately vibrate the concrete below the embed plate, using this method). As with the first option, after the concrete has been placed and cured, the contractor/installer simply cuts and removes the EPS foam from the pocket area, and the beam is then installed as per normal procedures.

INSTALLATION PROCEDURES

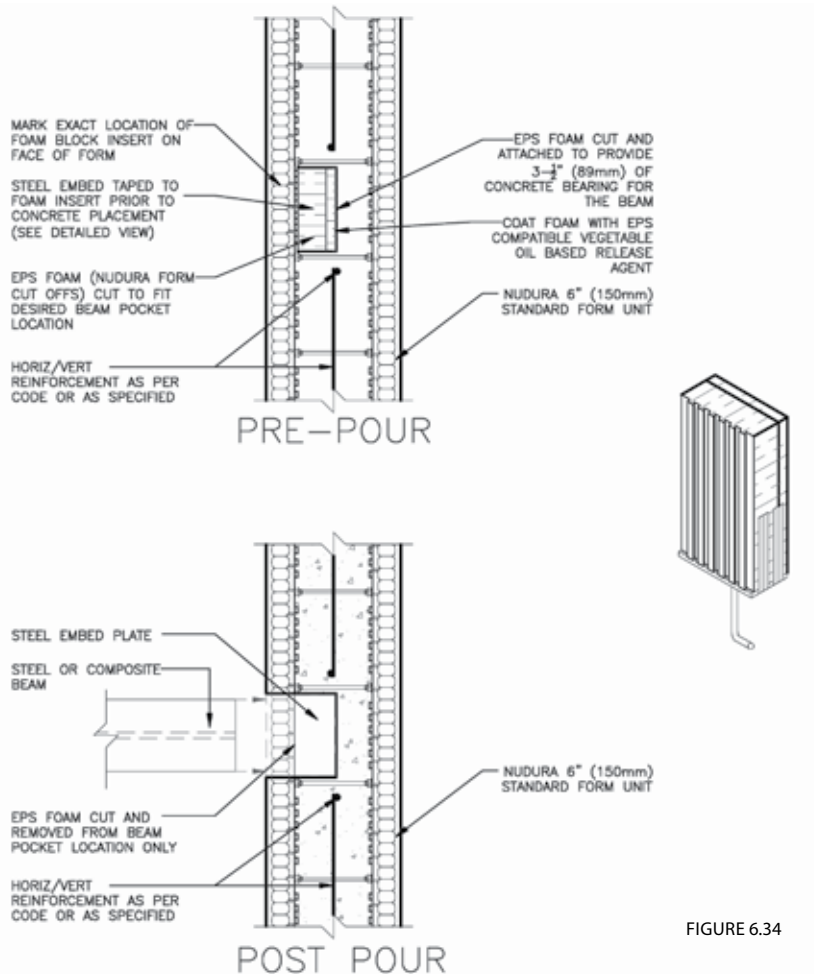

FIGURE 6.34

BRICK LEDGES

NUDURA's brick ledge form units have several uses, including supporting masonry loads and supporting floor joists. However, the brick ledge is not available in a corner form option (in any angle) and therefore the creation of an in-field corner brick ledge will need to be made. Installation of the standard brick ledge follows the same requirements as a standard straight form. Once the contractor/installer comes to a corner condition a decision needs to be made regarding the creation of a corner brick ledge.

Option 1- Full Form Miter Cut: One method for construction of brick ledge corners is to take 2 brick ledge forms and miter cut them following the profile of the corbel on the outside panel, and creating a square cut on the inside panel to complete a corner form condition. Remember that all cuts need to be performed away from the wall area to prevent a build up of EPS shavings (or foam fray) in the bottom of the wall. Once the miters have been completed, take both pieces of brick ledge and lock them onto the wall. NUDURA's 1" (25 mm) fiber tape will now be required to tape the corbelled corner and provide strength during concrete placement. Should the miter cuts on the corbel not be exactly tight together, the contractor/installer can fill any gaps using the low expansion spray foam. This will accomplish two things; it will add additional bonding of the two forms at the miter location and it will also fill the gaps, not allowing concrete to leak from this area.

Option 2- Corner Forms with Brick Ledge Extensions: The 2nd method that can be used is to construct the corner using the standard 90° or 45° corner form as the basic structural integrity of the corner condition, but then, fitting the form with NUDURA's brick ledge extension Form Accessories to complete the ledge condition. This method has the added benefit that it maintains the structural integrity of the standard corner form throughout the condition and can, in most cases, be a more cost effective option for constructing the corners. To see detailed explanation on the correct method of construction to be used for corner brick ledge option 2, refer to the brick ledge corner Assembly technical bulletin found under Appendix F in this manual.

INSTALLATION PROCEDURES

In either case, once the brick ledge condition has been constructed, the reinforcing steel can now be added to help support the brick that will be installed later in the construction process. The steel needed to accomplish the reinforcing for the brick ledge consists of 3 different pieces. The first is the horizontal steel location in the main cavity of the wall. Its location is critical as it helps to support the brick ledge hooks. NUDURA recommends that the horizontal steel be placed within the second notch of the web from the inside face of the form.

Also, this reinforcing steel will be required to have a contact lap splice in order for the hooks to be located correctly (see Figure 6.35). At the outer edge of the brick ledge (and the brick ledge extensions), the contractor/installer will also need to place a horizontal piece of reinforcing steel to allow the brick ledge stirrup to rest on. This piece of steel will not require a lap splice as it simply acts as a holder for the stirrups. The brick ledge stirrups can be created either in the field, or be provided pre-bent to the site by the reinforcing supplier. NUDURA can provide details showing the bend locations along with the required dimensions for the various wall thicknesses. Contact the local distributor for copies of these brick ledge hook details.

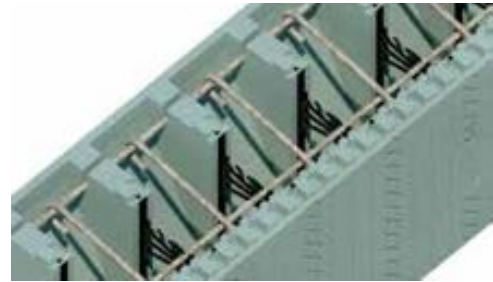

FIGURE 6.35

GABLE ENDS

If the structure is using parts or all of the roof section as habitable living area, and these areas include gable ends, it is beneficial and effective to use the NUDURA Integrated Building Technology wall system for these parts. One of the simplest methods for creating a gable wall is to use NUDURA's 8' (2.44 m) standard form units to build the gables by simply cutting the forms to the desired slope of the gable. Remember that the cut off portion of the panel is not waste and can be re-cut to form the opposing slope of the gable end. This results in little or no waste, depending upon the pitch of the roof. The cut edges of the gable will require additional support during concrete placement to prevent flaring out of the panels due to the cutting of the webs. Simply taking 1" x 4" (19 mm x 89 mm) or similar material and screwing into the fastening strips of the panels will ensure the gable ends maintain straightness during the concrete placement. The NUDURA alignment system then can be installed to support these areas as per section 6.6.



FIGURE 6.36

Should the gable wall have a window opening located within it, the buck options, temporary bracing, and anchorage into the concrete will be installed as per instructions given in section 6.5. The lintel reinforcement is also installed as per this section, and the reinforcing steel requirements are as per Appendix e of this manual.

When placing concrete into the gable ends, it will be necessary to reduce the overall slump from the typical 6" (152 mm) to about a 4" (102 mm) slump. Also, depending upon the gable end slope, it might be necessary to reduce the pour lift heights from 4' (1.22 m) to 2' (0.61 m). consolidation of each lift is critical to ensure voids do not occur within these areas. Proper consolidation techniques are discussed in section 6.10. Regardless of slope of the gable, with the reduced slump there is no fear of the concrete slipping out of position as the regularly spaced web network inside the forms serves to prevent this from happening.

Once the gables are completely filled with concrete, remember to screed the top of the walls flat, install the necessary anchors as specified, and adjust the walls to obtain straightness.

INSTALLATION PROCEDURES

PILASTERS

Pilasters can be created, using a number of different methods, from products already discussed in this manual. Here are some of the available options:

1. Pilasters constructed using T Form units and end caps
2. Pilasters constructed using the 4 Way Web Connector and NUDURA panels
3. Pilasters constructed from conventional form ply and attach this to the NUDURA form units

All of these methods will require additional form support, as portions of the wall will be compromised due to cutting of the webs.

T Form Unit Method: if the building requires a pilaster of 12" (305mm) or less, construction of the pilasters using NUDURA T Form units is a quick and easy option that will allow the contractor/installer the opportunity to build them fully using the NUDURA technology. The T Forms will allow the contractor/installer to build the pilaster as necessary to meet the specifications due to the fact that the forms come unassembled to the site. This helps in the placement of the steel reinforcement necessary for the pilaster to be placed where needed. It also helps the contractor/installer build this area similar to conventional forming by erecting the panels for 1 side of the pilaster, adding in the necessary reinforcement and then closing up the opposite side.

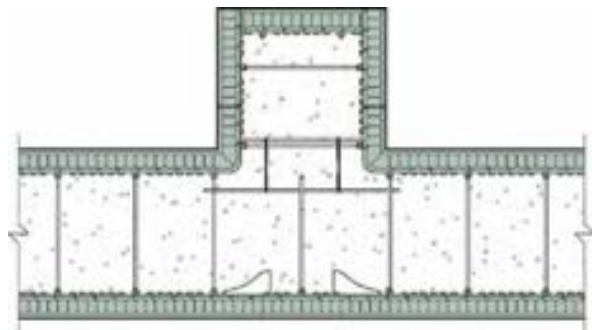

FIGURE 6.37

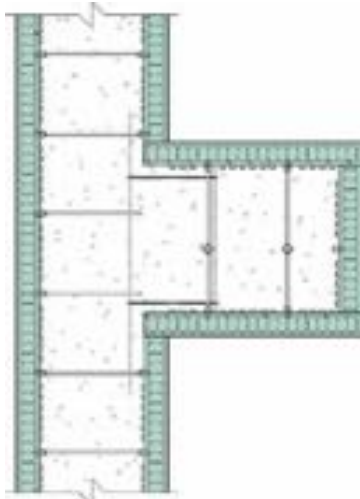

FIGURE 6.38

Panel and 4 Way Web Connector Method: Pilasters can also be created from NUDURA's panels, insert webs, and 4 way web connectors. These can be created by simply cutting the panels to match the required dimensions of the pilaster specified. A combination of insert webs to create the pilaster width and depth will require the use of NUDURA's 4 way web connector. For example; if the plans specify a 16" (406 mm) x 16" (406 mm) pilaster, a combination of 4 - 8" (203 mm) insert webs along with 1- 4 way web connector is required. Additional support will be required in the corners to prevent concrete from creating a problem during placement. NUDURA's low expansion spray foam will connect the panels together, giving the necessary bond strength to resist concrete.

Conventional Plywood Forming: The final option is to build the walls using the standard forms, cutting away the foam, and create a pilaster using regular plywood forming. This sometimes may be preferred due to the amount of reinforcing steel needed for the pilaster to support the loads imposed upon it. Should this be the method, simply cut out the required amount of foam from the main wall. Do not forget to add additional support to the opposite side of the NUDURA form to resist concrete pressure. Complete the pilaster as per normal techniques. Remember to tie wire the forming to the forms to ensure the pilaster does not move under concrete pressure.

ROOF CONNECTIONS

Before concrete is placed into the forms some additional steps need to be considered for connecting a roof to the concrete after it has cured. A couple of different methods can be used to connect a roof to the concrete walls.

- ICF Hanger System
- Simple Anchor Bolt
- Hurricane Tie Down Straps



FIGURE 6.39

ICF Hanger System: The ICF Hanger System can be used as a connection to accept the roof member and allowing a solid connection to the concrete wall. This installation method can be found in Appendix F of this manual under the heading of “roof/hurricane Anchor system”. One thing to remember is you will have to ensure you have your layout for the roof members before installing the ICF Hanger System.

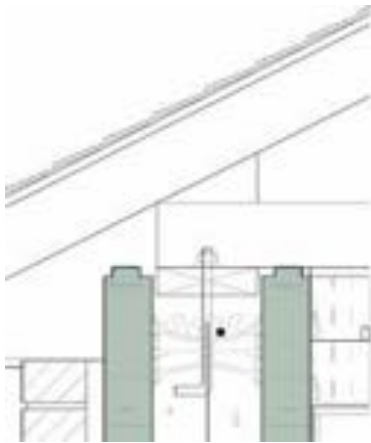

FIGURE 6.40

Simple Anchor Bolt: Anchor bolts can be set into the wet concrete at the required spacing as per the local building code. Typically, anchor bolts must be minimum $\frac{1}{2}$ " (12.7 mm) diameter but may be required to be $\frac{5}{8}$ " (16mm) diameter where prevailing wind loads dictate depending on the local building code requirement. The bolts are typically required to be embedded not less than 4" (100 mm) when final set into the top of the concrete in the formwork. Though bolts are typically spaced not more than 4' (1.2 m) apart, again depending upon the prevailing building code, seismic region and wind speed, bolt placement may be required to be as close as 16" (400 mm) o/c. Always consult with your local building code official to verify what is required for your region.

Specific roof anchor plate designs may vary from building to building, but when using a dimensional wood roof anchor plate with cast in place anchor bolts, the commonly preferred method is to have the roof anchor plate nested (fully protected) between the inner and outer insulation panels of the form with the top of the plate just clearing the top of the form insulation panels.



FIGURE 6.41

To achieve this feature during final concrete placement, the NUDURA installer may wish to consider creation of a simple wood hand trowel/concrete screed consisting of a plywood sheet cut to appropriate size, a simple handle mounted on top, and the bottom of the plywood plate being fitted with an 8" (203 mm) long scrap of wood measuring $1\frac{1}{2}$ " (38 mm) thick by the desired form core width (4,6,8,10 or 12" / 101,152, 203, 254, 305 mm). this screed can be used once the finished wall pour height is achieved, to screed the concrete level to the desired $1\frac{1}{2}$ " (38 mm) depth below the top of the form insulation. Using this in conjunction with a laser level can enable even greater accuracy for final plate placement. *This item is listed as Item 2 on the Tools for Concrete Placement Checklist under Section 6.10 (Concrete Specifications and Placement)*

INSTALLATION PROCEDURES



FIGURE 6.42

Wet set bolt placement at the specified locations and depth can be made once the concrete has been leveled as noted above. The concrete must be sufficiently set to ensure the bolts will remain vertical (section 6.10 for concrete placement methods).

Once the concrete has cured, a sill gasket with the proper sized wood anchor plate is then installed. After initial placement of the sill gasket over the bolts, transfer the bolt locations to the bottom of the plate and then pre-drill the plate with clearance sized holes to enable the plate to drop over the bolts. Once the anchor plate is finally anchored into position with finish washers and nuts, the typical layout for the roof system can be completed.

NOTE: For roof truss and rafter anchorage to the roof anchor plate, be sure to reference prevailing building codes for your region. Some regions may require the additional provision of “tension ties” to provide additional fastening of ceiling joists or bottom chords of the trusses to the top of the roof anchor plate at 48” (1220 mm) centers or even less spacing depending upon prevailing wind speed. These may be specified even over and above any required anchorage against hurricane force winds (as covered below).

Hurricane Tie Down Strap: The ICF Hanger System or a similar embedded strap system can be used for areas that require a roof connection to meet a specific wind speed or pressure typical for coastal areas. The manufacturers’ installation instructions need to be followed along with having the roof layout before any placement of concrete is placed into the forms.

NOTE: if a pre-engineered roof truss has been specified as the required roof system; ensure the bearing point for the truss is 2 5/8” (67 mm) back from the face of the NUDURA form as the EPS will not be able to support the loading conditions of the roof.

6.10 CONCRETE SPECIFICATIONS AND PLACEMENT

The concrete mix design shall meet the engineer's specifications and conform to national and local standards, regulations or codes having jurisdiction. The main characteristics and specifications for a NUDURA compatible concrete mix should be as follows:

- Portland cement: type 10 (normal)
- Designed compressive strength at 28 days: 3000 psi (20 MPa)
- Slump on site: 5" (125 mm) to 6" (150 mm)
- Water/cement ratio: Maximum 0.60
- Aggregate maximum size:
 - Wall Cavity of 4" (100 mm) and 6" (150 mm) nominal concrete thickness: $\frac{3}{8}$ " (10 mm) to $\frac{1}{2}$ " (13 mm) aggregate size
 - Wall cavity of 8" (200 mm), 10" (250 mm) and 12" (300 mm) nominal concrete thickness: $\frac{3}{4}$ " (19 mm) aggregate size
- No air entrainment (usually 3% to 5% present naturally)
- Fresh concrete density: 4080 lb/yd³ ± (2400 kg/m³ ±)
- Setting time (dependent on temperatures): 3 – 7 hours
- Concrete design strength should be reached at 28 days



FIGURE 6.43

Check this specification with your local concrete supplier. Most concrete companies now feature design mixes formulated with mid-range water reducers that are specifically designed to work in insulated concrete Forms systems. These mixes give better flow-ability of the concrete with reduced water content and more cohesiveness that assures no segregation of aggregate during placement.

The NUDURA form units made of EPS (expanded polystyrene) will enhance the curing of the concrete as follows by:

- Providing consistent curing environment for the concrete
- Giving excellent thermal protection in the cold weather and extreme heat
- Minimizing surface shrinkage which is the cause of cracking in concrete walls
- Controlling moisture loss inside the concrete while curing, which is the major cause of cracking
- Preventing moisture loss due to air/wind exposure

Typically, concrete design strength characteristics and number of days at which the design strength will be achieved are as follows:

- 3 days - the concrete achieves approximately 40% of its design strength
- 7 days - the concrete achieves approximately 60% of its design strength
- 28 days - concrete compressive design strength should be reached

The placement of concrete in the NUDURA forms shall be in accordance with the plans and specifications, and must comply with local standards, regulations or codes having jurisdiction. Various methods of placement can be used depending on the accessibility to the site and the characteristics of the project. Other variables such as temperature, mix design, and reinforcing pattern in the wall may influence the builder's decisions as to the technique selected for the concrete placement. Concrete can be placed using the following methods:

- Concrete boom pump
- Concrete pump
- Crane and bucket
- Conveyor belt on or off the truck
- Directly off the truck by chute

INSTALLATION PROCEDURES

The concrete boom pump is the preferred method for above grade construction when available. When using a boom pump it is important to have a reducer (diameter 4" (102 mm) maximum) followed by a double 90° bend to reduce the velocity of the concrete entering the wall. Some pumps are also equipped with a flap gate at the end of the double 90°. the flap gate is very useful in keeping the site clean, especially when working on slab or floor surfaces.

The contractor and crew should familiarize themselves with the proper technique and use of the vibration equipment supplied for the job before concrete placement begins. A recommended practice for a standard whip vibrator is to insert the vibrator full depth of the concrete lift at 2'-0" (600 mm) intervals and withdrawing the vibrator slowly at a rate of about 1 foot (300 mm) per second after each insertion.

Though following the practices recommended in this installation manual will assure maximum efficiency and safety during the pour, it's a good idea to ensure that preparations are made for handling a form blow-out, should anyone miss cross checking for adequate form support etc. The contractor should ensure that prior to concrete placement, one or more kits are prepared to have at the ready should such an occurrence arise. A blow out kit can consist of such simple materials as a 2'-0" x 2'-0" (600 mm x 600 mm) square of ½" (13 mm) plywood or multiple 2'-0" (600 mm) long grade stakes and no. 10 x ½" (63.5 mm) wood screws with a screw gun. Having these ready will save valuable time should a blow-out occur.



FIGURE 6.44

PRE-PLACEMENT CONCRETE CHECKLIST

- Is wall built according to drawing?
- Has all additional support been installed?
- Is rebar installed per plans or as specified in the correct location?
- Is lintel rebar installed correctly?
- Is NUDURA alignment system installed correctly?
- Have all openings been installed and in correct location?
- Do you have correct size of rough openings?
- Has proper anchorage for buck material been used?
- Construction joint reinforcement or protection for protruding rebar?
- Have all service penetration sleeves been installed?
- Have all T Form units been braced?
- Have all beam pocket preps. Been installed and in correct location?
- Have all string lines been installed around perimeter of building?
- Have walls been straightened?
- Has all interlock been protected?
- Is there adequate support on gable ended walls?
- If in winter construction, has form cavity been protected against snow or ice build-up on the night previous to the pour?
- If no protection had been provided, have measures been taken to remove all snow and ice from the forms?
- Are roof or floor connection anchors on site?
- Do you have a tool for consolidation? (Concrete vibrator)
- Are there back up materials in case of blowout? (i.e. blow-out kits and screw gun available)
- Is the concrete order as per code, or as specified?
- Has the quantity of concrete been properly calculated and checked against the build?
- Has the timing of trucks been properly coordinated with the plan for the pour and relayed to the concrete company?
- Is there enough room for concrete pump or trucks to maneuver on site?
- Has operator been made aware of all trees, roof overhangs and power wires?
- If pouring with a pump are there reducers along with a double 90° elbow?
- If pouring by other means is there enough room to maneuver around site?

TOOLS FOR CONCRETE PLACEMENT

- Magnesium trowels
- Homemade trowel to recess plate
- Concrete vibrator
- Laser level
- Hand level
- Ladders
- Wheelbarrows
- Normal hand tools
- Cordless drill and screws
- 4' (1.22m) and 8' (2.44m) straight edge
- Material for supplementary bracing and straightening
- Hand shovel

The operations outlined here are for a four man work crew and a typical residential pour. Please note that operations can vary widely from what is depicted here depending upon job complexity and size.

Slump of the concrete should be checked by the crew lead before placement begins to assure it is being pumped at the specified mix. Accurate records of the concrete delivery tickets should also be kept during concrete placement for later reference in the event that concrete testing is required.

Ideally, the lead hand should be working the hose alongside the pump operator on the catwalk platform. A laborer should follow immediately behind the lead hand with the vibrator, consolidating as the lift is placed. Communication between pump operator and the crew lead operator at the hose end is crucial. If the pump operator does not have remote equipment, radio, or clear hand communications between these operators will be essential for a successful pour.

Additional laborers should be on the ground assisting in mechanical vibration (external or internal) especially at window openings, and watching carefully for wall movement or potential situations that may arise due to concrete pressures filling various areas of the formwork. These crew laborers should also be ready with embeds or accessories and tools as needs may arise during the pour. The crew on the ground should always be cautious of the boom position and be ready to react in the event of any emergency that should arise with the pump equipment.

As per ACI 304 and CAN/CSA A23.1, (in north America) concrete placement rate should not exceed 4' (1.22 m) of lift per hour. When placing concrete the contractor should avoid stopping a pour against a buck or in a corner. A pour should always be terminated at the center of the longest wall when possible.

Consolidated concrete will be dense, homogenous, and free of cold joints, voids, and honeycombing. The concrete shall be well bonded to all reinforcing steel, anchors, and embedded parts, such as bearing plates. In the past, the ICF industry has commonly accepted hand-tamping, rodding or external vibration as adequate means for concrete vibration. However, historical experience has shown that these methods are not adequate to assure maximum reduced risk of honeycombing or voids developing within the concrete. Of all available methods, internal mechanical concrete vibration is the most effective method to use to assure the highest level of monolithic consolidation. Consolidation of the concrete should always start at the base of the wall and continue upward as each concrete lift is placed. The completed lift should be consolidated before the next lift is deposited.

When consolidating subsequent lifts, the consolidating tool must completely penetrate the lift and extend into the upper portion of the previously placed lift, to ensure proper mixing of the concrete at the interface between lifts. A $\frac{3}{4}$ " (19 mm) to 1" (25 mm) concrete vibrator is the maximum size recommended for consolidating concrete in a NUDURA wall. Be sure that the shaft length of the vibrator is long enough to reach the bottom of the wall height being constructed.

INSTALLATION PROCEDURES

As the concrete placement operations near the top of the wall pour, one of the ground laborers should move to the scaffold platform to assist with embed placements, beam pocket screeding and wall leveling. A laborer should remain on the ground to assist the crew lead with the alignment system checks. An initial alignment should be made to plumb and to assure visual straightness. Once the crew has completed leveling, screeding, and anchor bolt and embed placement, the crew lead should complete fine adjustment with a single laborer on the ground to ensure that minimum movement of the alignment system is made during the final plumb and straightness checks of the wall installation.

Once the work is complete, the crew finishes off with final clean-up of the site and the equipment and completing the post-placement checklist.

POST PLACEMENT CONCRETE CHECKLIST

- Have the walls been preliminarily straightened to plumb?
- Are openings plumb?
- Have all walls been properly consolidated?
- Has the top of wall been screed level?
- Have all beam pockets been screed to level where accessible?
- Have all anchor bolts and embedment has been installed and concrete consolidated at these inserts?
- If continuing up wall, is all cold joint reinforcement in place with proper lap splice and top of concrete left rough?
- Once all cross checks completed above, has final fine adjustment of all walls been completed using installed string lines, tape measure and laser level?
- Have all tools been cleaned and put away?
- Cold weather pouring – has top of wall been protected from freezing?
- Has alignment system been cleaned of all excess concrete?

7.0 DAMPROOFING/WATERPROOFING

7.1 PEEL & STICK MEMBRANE

NUDURA Damproofing/Waterproofing Membrane is a self adhesive peel and stick membrane designed for below grade damproofing and waterproofing applications. It is composed of styrene-butadiene-styrene (SBS) modified bitumen and a polyethylene woven complex. This surface provides 100% protection from UV radiation. A silicone release paper protects the adhesive side of the membrane.

Building codes require damproofing/waterproofing when the interior floor level is below the exterior grade level. NUDURA offers a peel and stick membrane that satisfies the code requirements and offers a warranty against manufacturers defects. NUDURA offers three different application scenarios depending upon the code requirements and individuals' preference. The three scenarios include:

1. Membrane applied directly to the face of the wall
2. Membrane with 6"-12" (152 mm-305 mm) NUDURA Membrane Primer at the grade line and footing junctions
3. NUDURA Membrane Primer and membrane over the entire wall



FIGURE 7.01

These three methods have been extensively tested and found to perform extremely well on the EPS (expanded polystyrene) foam. It is very important that the surface of the EPS foam be clean and dry before any of the above mentioned methods are started. NUDURA offers two types of membranes that perform well in extremely different climates. The summer grade membrane, identified by a black dotted line on the carrier sheet surface, adheres to the EPS foam in weather conditions of 50° F (10°C) and above. The winter grade membrane, identified by a blue dotted line in the carrier sheet surface, can be applied to the NUDURA EPS foam in temperatures as low as 14° F (-10° c).

Properties	Standards	NUDURA Waterproof Membrane	
		Metric	Imperial
Thickness	-	1.0 mm	40 mil
Dimension	-	22.9 x 0.91 m	75 ft x 36 in
Gross / Net coverage per roll	-	20.8 / 19.1 m ²	225 / 206 ft ²
Roll weight	-	20 kg	44 lb
Top face	-	Polyethylene woven complex	
Under face	-	Silicone release paper	
Tensile strength, MD/XD	ASTM D5147	11.3 / 15.4 kN/m	64 / 88 lbs/in
Ultimate elongation, MD/XD	ASTM D5147	52 / 24 %	
Flexibility at cold temperature	ASTM D5147	-30 °C	-22 °F
Static puncture	ASTM D5602	400 N	90 lbs
Tear resistance, MD/XD	ASTM D1876	375 / 400 N	85 / 90 lbs
Lap adhesion	ASTM D1876	2000 N/m	11.4 lbs/in
Peel resistance	ASTM D903	3050 N/m	17.5 lbs/in
Water absorption	ASTM D5147	< 0.1 %	
Water vapour permeance	ASTM E96 (Procedure B)	< 0.90 ng/Pa.s.m ²	< 0.016 perm

(All values are nominal)

7.2 DISCLAIMER ON PRODUCT

Although NUDURA's Peel and stick Membrane technical bulletin and data sheet reference the product as a "waterproof Membrane", other elements of the foundation must also be completed in order for this product to fall under the code requirements of a waterproofing system. It is ultimately the contractor/installer's responsibility to ensure the requirements regarding a "waterproofing system" outlined within the local building codes are met. Should any elements of the building code not be followed, the peel and stick membrane cannot be held as the sole reason for any moisture migration through a foundation wall. For example, the membrane cannot be required to resist the passage of moisture through the wall sections if:

- (a) Improper installation of the drainage tile and a method to drain away excess water from the structure has not been provided, and/or
- (b) Incorrect sump pump sizing and installation, and/or
- (c) The failure to backfill with free flowing granular material or providing an additional drainage layer on top of the membrane as per code, and/or
- (d) Final grade has not been established along with proper eavestrough and downspouts.

These must conform according to the local building codes and failure to comply will result in the membrane performing below expectations.

Finally, should the structure incur hydrostatic pressure from the fluctuation of the water table below a building, the membrane cannot act solely as a material to resist these conditions. The contractor/installer must reference the local building codes and follow the requirements outlined within the appropriate sections in the code. NUDURA Inc. will not be held responsible for the incorrect installation of the membrane should it be determined other elements of the code were not properly followed.

7.3 MATERIAL STORAGE AND CARE

Care should be taken to protect the membrane on site from moisture, dust, and general wear and tear. Store membrane rolls in a cool, dry location (not in direct ground contact) and protect with a tarp to prevent exposure until the membrane is ready to be used.

On colder days, store the material in a heated location on site until needed. (A heat gun can also be used to assist in application of the membrane onto the wall).

NUDURA's membrane should not be exposed to sunlight for extended periods of time. Backfilling should take place within 1 week of installing the membrane. If daytime temperature exceeds 80°F (27°C) after installation, NUDURA recommends shading the applied membrane temporarily until backfilling is complete.



FIGURE 7.02

7.4 INSTALLATION

For detailed instructions on how to apply NUDURA Damproofing/Waterproofing Membrane, please refer to the technical bulletin on NUDURA Damproofing/Waterproofing Membrane included in Appendix F.

7.5 WARRANTY

NUDURA provides a limited manufacturer's material defect warranty on its peel and stick waterproofing membrane product.

NUDURA® Inc. 5 Years Material Warranty

Product (s):

Subject to the following and conditions, NUDURA® Inc., a legally constituted corporation with its registered office at 27 Hooper Road, Unit 10, Barrie, ON, L4N 9S3, hereafter referred to as COMPANY, warrants the above named products, hereafter referred to as MEMBRANES, supplied for the waterproofing of ICF foundations, is free of manufacturing defects.

Should any defects be discovered during the installation or in the 5 year period after the completion of the application of the MEMBRANES, COMPANY undertakes to, at its option:

1. a) supply an equal amount of MEMBRANES for the replacement of the defective membranes, or,
2. b) pay the owner of the building the cost of replacing the defective MEMBRANES as determined by COMPANY at the time of the claim.

This warranty may be enforced only if the purchaser has paid COMPANY in full for the MEMBRANES. Subject to the other provisions of this warranty and without limiting the generality thereof, COMPANY shall not be held liable or have any obligation if any damage whatsoever is caused by the following, or if repairs are required because of the following, the whole without limitation:

- a) faulty or otherwise unacceptable installation inconsistent with the state of the art and/or disregard of, COMPANY's standards and specifications,
- b) improper or abnormal use of the MEMBRANES supplied by COMPANY,
- c) alteration or modification of COMPANY's MEMBRANES,
- d) use of primers, mastics, adhesives and other than those specifically manufactured or supplied by COMPANY to be used with COMPANY's MEMBRANES,
- e) faulty building design or construction, abnormal performance of the building's structure,
- f) water infiltration or moisture condensation on, into or around adjoining work or equipment, or at any location under or adjoining the MEMBRANES supplied by COMPANY,
- g) alterations, transformations, additions or repairs to the MEMBRANES or installation of equipment or any other device after the MEMBRANES installation,
- h) falling objects, regardless of source,
- i) acts of god including, without limitation, war, riots, uprising, acts of terrorism and natural catastrophes, including but not limited to floods, hail, lightning, earthquakes and windstorms,
- j) movement or deterioration of a material adjacent to the MEMBRANES or incorporated into materials used as a direct or indirect base for the MEMBRANES,
- k) chemical damage to the MEMBRANES,
- l) use of COMPANY MEMBRANES in the construction of a building when the building and/or MEMBRANES has not been designed for such use,
- m) a change in the purpose or use of the building, as well as a change to the building or to its occupancy, where such change could compromise the effectiveness of the MEMBRANES supplied by COMPANY or make them inappropriate for use in the building.

DAMPROOFING/ WATERPROOFING

The recourse stated herein are the sole and exclusive recourses for failure of the MEMBRANES, and excludes any other claims especially for any kind of damages. No representative, employee, or agent of COMPANY or any other person, has any authority to assume for COMPANY any additional or other liability or responsibility for COMPANY unless it is in writing and signed by COMPANY's General Manager.

There are no warranties either expressed or implied, including the implied warranties of merchantability and fitness for a particular purpose, which extend beyond the warranties contained in this document. COMPANY shall not be liable for any incidental, consequential or other damages, including but not limited to, loss of profits or damages to the structure or its contents arising under any theory of law whatsoever.

Any claim which may give rise to the COMPANY's liability hereunder shall be made in writing to COMPANY during the warranty Period, at the address of the office set forth above, immediately after the defect or deficiency covered by the warranty occurs, failing which this warranty shall not be enforceable upon it. The owner shall also forfeit its recourse if it effects any repairs, except for emergency reasons, before COMPANY or its agent has had the opportunity to inspect the condition of the premises and issue a written authorization regarding the repair solution and the conditions relating thereto, if any.

NUDURA® Inc.

8.0 PARGE COAT (PREPCOAT B2000)

As with all NUDURA products and accessories, the parge coat material is another of the important elements of construction that's unique to the NUDURA installation procedure. Parge coat is a term used by masons to define the thin coat of cementitious or polymeric mortar that is applied to concrete for refinement of its surface.

As is common in conventional construction methods, the purpose of parge coat is to provide smooth finish of the band of foundation wall surface that is typically exposed between the final grade of a building and its intended above grade finish material. This is especially true in more northerly climates where, because of snow and frost penetration in ground, building codes require a definite separation of the grade from the above grade installed finish, usually a minimum of 6" (152 mm).

When applied to NUDURA EPS foam, the parge coat is typically applied to lap overtop of the NUDURA Damproofing/Waterproofing membrane that is installed to approx. 6" (152 mm) below the projected finish grade level, and then extends to either the underside of a brick or stone veneer finish or laps approximately 1" (25 mm) underneath any non-brick finish applied to the above grade walls. As outlined in this section, the parge coat is typically applied in 2 coatings – each between $\frac{1}{32}$ " - $\frac{1}{16}$ " (0.8 mm - 1.6 mm) in thickness with a fiberglass mesh interlay that is applied and floated into the first coat.



FIGURE 8.01

PRODUCT DESCRIPTION

The material used for this purpose is Precoat B2000, an acrylic-modified cementitious dry mix base coat that is specifically designed for use over high-density expanded Polystyrene (EPS) insulated concrete Forms (ICF). B2000 forms a strong, yet flexible, base coat that eliminates problems normally associated with jobsite mixing of parge coatings (i.e. the addition of Portland cement). One 50 lb (22.7 kg) bag covers approximately 80 sq ft (7.5 sq m) wall area at a thickness of $\frac{1}{12}$ " (2 mm).

In addition to the Precoat B2000, a fiber mesh is also required during the installation of the parge coat. The fiber mesh comes in rolls that can cover 475 ft² (44 m²) of wall area. The purpose of the fiber mesh is to help strengthen the parge coat and ensure no shrinkage cracking will occur once the Precoat B2000 has completely cured.

PRODUCT FEATURES

- High Flexural and Bond Strength
- Water Vapour Permeable
- Excellent Freeze/Thaw Stability
- Low water Absorption
- High Workability
- Low Shrinkage



FIGURE 8.02

PARGE COAT

TECHNICAL DATA

Cohesive Strength:

- 2316 psi (15.8 MPa) after 3 days
- 3219 psi (22.6 MPa) after 7 days
- 3697 psi (25.5 MPa) after 14 days

PRECAUTIONS

Store the Prepcoat B2000 off the ground in a dry place away from direct sunlight. Make sure the EPS (expanded polystyrene) is free of dirt, frost, moisture, loose material, paint, or any other foreign matter. Make sure the surface and ambient temperatures are 41°F (5°C) or greater when applying B2000 and remain so for a minimum of 24 hours. Allow the B2000 to dry for a minimum of 24 hours before applying additional coats. Protect B2000 from winds exceeding 15mph (24 km/h), from rain, hail, snow, and all other possible damage until it has fully set and dried, and until all capping, flashing, and caulking have been completed.

8.1 MIXING INSTRUCTIONS

Gradually add one bag of B2000 to 1 imp. Gal (4.5 liters) of clean, potable water being continually mixed until a workable consistency is obtained.

1. Let the mixture stand for five minutes, then remix and use. Pot life is one hour.
2. Up to 8 oz (225 ml) of water may be added to enhance workability if mixture begins to stiffen before the hour expires.
3. Mixture may be remixed one time only. Afterward, discard any material that has begun to stiffen.

8.2 INSTALLATION INSTRUCTIONS

There are 4 key steps to ensuring the parge coat is properly installed onto NUDURA EPS. By following these installation processes, this will ensure the Prepcoat B2000 performs effectively on the EPS.

1. Rasp the NUDURA EPS foam to improve coating adhesion, and to remove waves, bumps, and UV degradation. Rasing tools commonly used for the EIFS stucco market work ideally for this purpose. Consult with your local builder supply warehouse for this type of specialty tool.
2. The contractor/installer then needs to mix and trowel or spray apply the base coat of Prepcoat B2000. As stated earlier, the B2000 should extend from 1" (25 mm) above the bottom of the exterior finish to 6" (152 mm) below grade, overtop of the NUDURA peel and stick membrane to form a drip edge that will shed any moisture to the ground. The 6" (152 mm) measurement will allow the parge coat to over lap the peel and stick membrane by 1" (25 mm). The B2000 can be trowel-applied with a stainless-steel trowel, or spray-applied through a ¼" (6 mm) orifice at 20 psi (145 kPa). When applying the Prepcoat, the single individual coats should not exceed ⅛" (3 mm) in thickness.



FIGURE 8.03

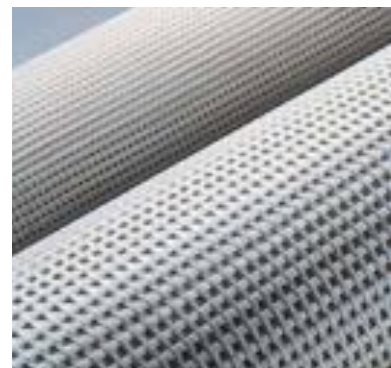

FIGURE 8.04

3. Immediately embed alkali-resistant fiberglass reinforcing mesh into the first coat. NUDURA recommends putting a double mat of fiber mesh on inside corners, outside corners, and corners of openings. These areas are susceptible to increased damage from exposure to every day events. Overlap the fiber mesh joints a minimum of 2" (50 mm). Apply additional coats of Precoat B2000 until the mesh pattern is not visible.
4. Apply the finish coat of B2000 24 hours after the base coat has been applied. Architectural designs now can be created on the finish coat to suit the requirements of the structure.

8.3 FINISHES TO PARGE INTERFACING

Should the exterior finish be directly applied acrylic stucco, the Precoat B2000 will still need to be applied to the section of wall that comes in contact with the finished grade. Most direct applied acrylic stucco manufacturer's products are not designed to resist the alkalis present in soils, and may breakdown over time. Please check with the stucco manufacturer for their recommendations for correct interface of their coatings with Precoat B2000 at grade level. If the recommendation is to use the Precoat, the same installation steps must be followed.

9.0 OPENINGS

This section of the manual is intended to give the contractor/installer guidance for installation of the doors and windows into the rough openings that were created prior to concrete placement outlined in Chapter 6, Section 6.5. As with all installations, NUDURA recommends that the contractor/installer follow all of the window and door manufacturer's installation methods. Window and door locations within the opening will be determined from the details within the plans and specifications.

9.1 OPENING PREPARATIONS

This Section is intended to help guide a window installer in one suggested method of preparing an opening to receive a window or door. However, prior to commencing any work, the Installer should follow the FOLLOWING practices:

1. Consult all local governing Codes and Standards to determine applicable legislation pertaining to requirements for flashing of window and door openings: These may include or refer to the following applicable standards.
 - a) USA - ASTM E2112 - 07 Standard Practice for Installation of Exterior Windows, Doors and Skylights
 - b) CAN – CSA A440.4-07 Window, Door, and Skylight Installation (Revised - 2012)
2. Consult with the supplying door or window manufacturer for their recommended procedures as it pertains to installation of their product into ICF for the local prevailing jurisdiction. In case of conflict, note that the prevailing local code and standard will govern the method to be followed over manufacturer or the following suggested methods.

Before windows and doors can be installed, the owner will need to know the designer's preferred placement position of the window or door frame within the depth of the NUDURA Wall (this is also discussed earlier under Section 6.5). This is necessary as it will vary how the installer will prepare the opening for receiving the window or door. (The various typical positions of window installation are reviewed under Section 9.2)

The following steps describe one suggested method for preparing an opening when installed in NUDURA forms. The method presented here concentrates on the required installation operations for flashing and installing windows that have been fitted with nailing strips that are intended to position the window frame towards the EXTERIOR surface of the NUDURA wall (as opposed to the center or interior of the depth of a NUDURA Wall), however, the same principles used to effect flashing and required drainage in this description can be applied to doors or any other type of through wall penetration occurring through a NUDURA Wall and to a variety of frame depth settings within the wall.

Prior to beginning installation, the installer should first consider what type of sill drainage will be used below the window. The drainage can be facilitated by:

- a) a membrane based flashing system that will be installed to positively drain any potential leakage from below the sill area OUT to the exterior of the opening.
 - b) a pre-manufactured plastic or metal sill pan accessory or
 - c) a combination of both materials for double protection if desired
1. Begin by cutting several 6" (152 mm) wide lengths of NUDURA Waterproofing Membrane complete with paper backing installed on the material. This material may need to be cut wider depending on the depth at which the frame will be final positioned within the wall. In lieu of NUDURA Waterproofing Membrane, other APPROVED flashing materials may be considered for use - however it is vitally important that the material selected have excellent adhesion qualities with EPS foam AND that it is able to take significant exposure to repeated freeze-thaw cycle without risk of the adhesion system breaking down over time.
 2. Ensure the opening surfaces at the window opening area have been cut reasonably square and flat and that any voids in the EPS foam have been filled and trimmed to smooth plane surface of the intended daylight

COMPLETION OF OPENINGS

opening for the window. The surfaces being prepared should be clean, dry and free of dirt, dust or debris that could potentially reduce or impair proper adhesion of the membrane. Also, check the level of the sill both horizontally and back to front of the opening depth to ensure that it is reasonably level and not negatively sloping inward across the window depth. Take measures to CORRECT any negative slope of this surface before window installation continues by adding material as required. This can often be remedied by purchasing a non-wood based beveled siding material cut to the full width of the opening and screwing it in place to the concrete or to the top of the NUDURA web materials. Screw the material to ensure that it is positively sloping downward towards the exterior of the opening. If you elect to use a beveled product at the base, be sure to cut two or three 1" (25 mm) wide segments of the same material to use as shim blocks for later setting of the base of the window to keep it level.

3. If using a membrane sill flashing, begin by measuring the distance from the projected final interior edge of the window frame to the interior surface of the NUDURA wall and rip cutting a 3/8" (10 mm) thickness of plywood to this width. Finally, cut this plywood piece to the width of the opening and nail it in position at the sill to provide a water dam that will prevent any moisture that might collect below the window sill from getting farther inside the opening. (This 3/8" thickness MUST be accommodated in the window rough opening size prior to concrete placement). (NOTE: A dam strip is NOT required if a sill pan is being used)
4. Using a strip of NUDURA flashing, peel back the paper release and carefully apply the membrane over the sill area – ensuring the end of the cut strip will lap UPWARD on either the left or right jamb condition by a minimum of 4" (102 mm) AND so that the interior edge of the membrane will lap UPWARD and over the vertical surface of the plywood dam strip.
5. Press the membrane into position smoothing the surface into the surface of the EPS foam and concrete as required, ensuring that the interior corners where the dam strip meets the jamb condition are appropriately trimmed and caulked or sealed to assure that no moisture can flow inward through these locations.
6. Repeat step 4 for the opposite jamb and lap the materials in the center of the opening. On wider windows, cut an additional strip to fill the gap between both jambs taking care to lap each material by at least 2 to 3 inches (50 to 76 mm) and ensuring each piece laps upward over the front edge of the plywood dam strip.
7. At the exterior surface, care must be taken to cut and lap the flashings at the corner conditions. In each case the jamb flashing must positively discharge OVER the sill portion of the flashing. If for whatever reason, the architect or local codes require a weatherization barrier such as Tyvek or Typar to be applied over the complete exterior wall surface, the NUDURA Membrane must lap OUTWARD and seal positively OVER TOP of this material.
8. In lieu of or in addition to the above method, the area below the window can be fitted with a 2 piece expandable plastic or metal sill pan accessory that has been design to flash upward on all edges and be fully sealed at each interior corner, which eliminates the need for the dam strip and contains the added bonus of providing a monolithically formed exterior fin that positively seals against the front face of the opening. The sill pan should be opened to the full extent of the window width and secured temporarily in position. Since it is usually a 2 component accessory, the joint needs to be fully sealed using a segment of one of the strips of NUDURA Waterproofing membrane. Be sure the membrane laps and seals upward on the rear upturn of the pan.
9. Next, apply jambs flashings using the NUDURA waterproofing membrane strips by lapping the 4" (102 mm) upturn at each jamb and continuing up the jamb to the head condition. Again, the front facing portion of the flashing must positively discharge overtop of the sill flashing and if using a sill pan, be sure this flashing positively overlaps and seals the jamb fin of the pan. Ideally the NUDURA WP Membrane strips should be cut longitudinally for this purpose so that they can be applied in one continuous strip. If the strips have been cut in 36 inch segments, be sure that they are applied in shingle fashion starting at the sill and working your way to the top of the opening positively lapping and adhering each segment OVER the segment below assuring a minimum 2 inch (50 mm) lap. As in Step 7, if Air Barrier membrane has been required to be applied to the exterior, the jamb flashing must seal OVER this material at the window opening.
10. On the interior, be sure that a vapor barrier material (ideally 6mil minimum thickness polyethylene vapor barrier sheet) is extended from the interior surface of the NUDURA form around the complete perimeter of the window or door opening and extending inward towards the frame's intended final position to meet the exterior flashing materials that were installed in the steps above. This is to be sure that the window or door frame can be final sealed in contact with this barrier once the window or door is installed.
11. The opening is now ready for window (or door) installation.

9.2 WINDOW AND DOOR INSTALLATION METHODS

The installation of doors and windows into their associated openings must be performed as per the manufacturer's installation instructions. With that in mind, as stated earlier in this section, the location within the rough opening can vary depending upon the requirements of the building and the designers' specifications.

WINDOWS

For windows there can be 3 different locations for installation into the rough opening.

1. Locations of frames flush to the outside of the wall assembly (most popular for North American Locations). Care must be taken to ensure that proper flashing installation will shed any moisture around the opening and down to ground level. If a manufacturer recommends the flange on a window frame be nailed to the wall assembly, NUDURA recommends, in lieu of nails, the window needs to be fixed to either the webs or the surrounding buck materials installed within the wall, using screws.

Since window frame depths will typically vary from as little as 2 ½" (64 mm) to usually no more than 5" (125 mm) typically, the difference in thickness between the inside of the frame and the interior finish surface of the wall is usually made up by installing wood jamb extensions or gypsum board returns for head and jambs, and usually wood or laminate board or ceramic tile or marble finish for the sill extension. (Gypsum board is normally not recommended for sill returns due to the wear that they may receive from use.) Windows and doors can be ordered with a return "J" and then trimmed with the preferred jamb material.

Another option would be to order the windows and doors with the required jamb depth already installed onto the frame. This may be the preferred method if the contractor's/installer's clientele does not want a joint or seam around the window or door. Some contractors/installers might prefer to use drywall returns in this area along with a tile sill as an option. Again all of these methods are based upon preference of the contractor/installer or the client the building is being constructed for.

2. Location of frames at the center of the depth of the opening. Again, care must be taken to ensure that proper flashing is in place, as outlined previously, before and after the installation of the window. Exterior finishes will determine the type and method of flashing to be used around these areas. The window will need to be fastened into the rough opening using screws either into the buck material or directly into the concrete. Remember that shims may be necessary to ensure the window is level and plumb within the opening.
3. Location of the frames fully to the inside of the rough opening, with the exterior finish wrapping into the opening area. (This method is more preferred for European Installations.) Again, the contractor/installer needs to install proper flashing as required. The fastening will now take place on the inside face of the wall using screws as the method of connection. Remember that a solid connection into the concrete or the buck material must be completed using the appropriate screw type. These types of windows can have jambs that accept drywall returns instead of extended wood or gypsum board returns at jamb and head.

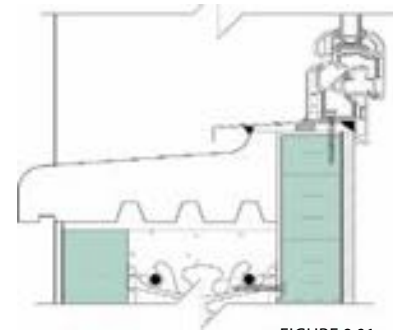

FIGURE 9.01

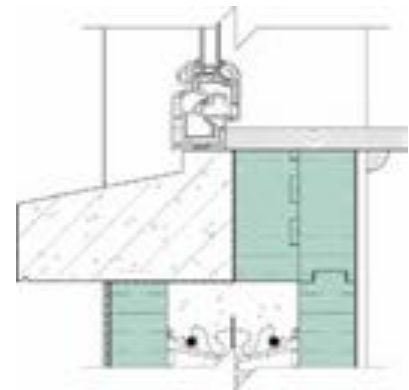

FIGURE 9.02

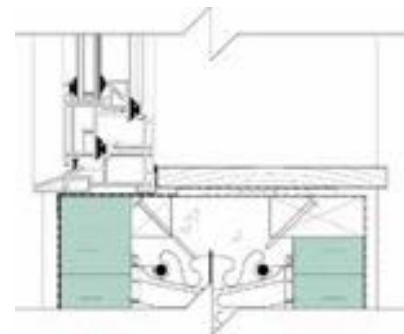

FIGURE 9.03

COMPLETION OF OPENINGS

DOORS

Doors typically have only 2 options for installation to allow for the maximum swing of the door to occur during operation. The most common method for door installation in most North American residential applications is to install the door towards the inside face of the wall assembly. This will allow the door to swing inward from 90° up to approximately 180°, depending upon interior walls. A solid buck material will be required for the hinge side of the door to ensure a long lifespan for the hinge connection point. This buck material should have minimal flex to ensure that there is no movement when the door is in operation.

Alternatively, should the design call for the door to be placed towards the outside of the wall assembly, the door will have to be fastened the same as the option above, but swinging outward (this may be dictated by code if required for fire exit or egress). Again, the intention is to maximize the swing of the door when fully opened (though this will be limited as normal with brick veneer finishes if no glazed sidelights are provided in the door frame). Shimming may be required to ensure the door is plumb once fastened to the buck material. Additional anchorage also needs to be provided for reinforcing of the door locks and dead bolt locks to ensure proper depth and security is achieved.



FIGURE 9.04

9.3 FLASHINGS – DRIP FLASHINGS AND FINISH AIR BARRIER SEALS

After window and door installation has been completed, the openings must be properly sealed and flashed, both inside and out.

Again the same caveats for following local Codes, Applicable Standards and manufacture instruction for flashing within ICFs (as noted under Section 9.1 (Page 105) shall apply and take precedent over any suggested methods outlined below:

EXTERIOR

The following suggested method can be used to complete the installation of the required flashings around the windows and doors once they have been installed regardless if the frames contain nailing strips or not. For frames without nailing strips, however, additional care must be taken in the application of the membrane to allow the membrane to lap outward onto the portion of the frame that is projecting beyond the surface of the NUDURA form and taking care to shingle lap the membrane downward over the corners at the head of the frame of the frame:

1. Position precut shim blocks at $\frac{1}{4}$ points in the opening, set and level the window per manufacturer's recommendations. The nailing strip can be pre-caulked to provide additional protection, however- refer to the window manufacturer's recommendations with respect to this operation. Center the window in the opening, and secure in position as per their instructions and test the window to ensure opening mechanisms function properly.
2. Apply NUDURA WP Membrane strips vertically down each jamb to lap OVER the Window Nailing strips. DO NOT apply membrane along the sill area as this MUST be left clear to enable the sill pan or sill flashing to drain should water succeed in getting through to the pan area.
3. Apply head flashing continuous over the top nailing strip. Care must be taken at the corners as shown to positively lap the head flashing OVER the jamb flashings. For radius top windows, the NUDURA membrane should be applied in short segments starting at the base of the curve and shingle lapping the segment upward and around the radius.



FIGURE 9.05

COMPLETION OF OPENINGS



FIGURE 9.06



FIGURE 9.07

4. Finally, make a horizontal angular upward kerf cut into the NUDURA EPS foam above the head of the window 1" to 1 ½" (25 to 40 mm) deep, for the full jamb width plus 2" (50 mm) on each side of the jambs. Cut and bend an aluminum drip cap flashing to match the kerf cut slope and length and friction fit the flashing upward into the kerf cut to assure positive drainage out overtop of the head flashing.
5. If air barrier membrane is additionally required to cover the NUDURA wall, in lieu of Step 4, and prior to Step 12, the air barrier film must be cut upward and outward at a 45° angle sufficient to allow for the head flashing to be installed. This material will be taped temporarily curled up out of position. After completion (assuring that the NUDURA WP Membrane covers the full width and height of the cuts made above), the air barrier material will then be lapped downward over the NUDURA WP Membrane strip and "skip-taped" using approved air barrier tape to allow for drainage of the air barrier ABOVE the window. Do NOT tape continuously at this location.



FIGURE 9.08

The opening is NOW ready for final exterior cladding to be applied.

INTERIOR

The only remaining detail is to caulk or foam seal the window and door frames to the vapor barrier seal applied around the inside perimeter at the frame extension area of the opening. Once this is completed, interior finishes can be applied as outlined under Chapter 13.



FIGURE 9.09

10.0 ELECTRICAL

10.1 CODE COMPLIANCE

As with all aspects of construction, the electrical within a building is also dependent upon code compliance. The electrical will need to conform to the local electrical authority or the appropriate code body and the applicable standards for the region. Local inspections of the electrical will be required before additional work commences on a building.

There are some differences from conventional building material, compared to the NUDURA Integrated Building Technology, when running the wiring and affixing the electrical boxes to the EPS that is explained in detail below. Panel locations and installation options will also need to be planned for as these also might differ from conventional building techniques.

10.2 THROUGH WALL PENETRATIONS

As mentioned earlier in Section 6.7 (Service Penetrations), before concrete is placed within the forms, the NUDURA contractor/installer will need to install the required size of PVC sleeves through the forms, and use the low expansion spray foam to secure these sleeves in place wherever electrical service needs to be run IN or OUT through the exterior walls (i.e. incoming electrical service from the meter, exterior lighting, exterior electrical outlets, service to out buildings on the site or pole lighting etc. on the property). Locate the sleeves approximately 6" (152 mm) offset from the exterior box location. This permits the wire to come into the side of a box and it also allows for proper attachment of the box to the concrete wall. The sleeve length can be the same as the form width, though many electricians make it shorter so that, after wire installation, NUDURA low expansion spray foam can be used around the sleeve ends to provide a thermal break.

To make the hole for the sleeve, use the sleeve as a template and pencil mark the circumference on the foam. A keyhole saw is often easier than a drill to cut the hole. A snug fit is preferred by most, but some will make oversized holes and fill the annular space with the low expansion spray foam. After the pour, when cutting the wire chase up to the sleeve, simply cut and break out the sleeve wall back to the face of concrete to enable the wire to bend over into the foam chase and run to the box. In lieu of a sleeve, a hole can be drilled through the concrete after the pour, or a wire chase can be cut down the exterior foam panel from the top of the wall. After the wire is pulled through the sleeve or hole, low expansion spray foam should be used around the wire to seal the opening.



FIGURE 10.01

10.3 PANEL LOCATION

To gain easy wiring access to the main circuit breaker panel through the floor or ceiling, it's best to install the panel on the opposite side of where the meter will be installed. If this option cannot be achieved then the panel will need to be installed as close to the main electrical wire coming from the meter as possible. If mounting the main panel onto the NUDURA Integrated Building Technology, it has been found easiest to attach the panel on a larger 1/2" (13 mm) thick plywood base. The plywood base can then be either fixed using screws to the fastening strips or a longer concrete screw can be used for direct connection to the concrete wall. This enables the wires to be stapled to the plywood in a neat series of lines for easy tracing.



FIGURE 10.02

If concealing the wires is a requirement, fur out around the plywood base mount with 2" x 4" (38 mm x 89 mm) studs. Remember that the EPS will require a thermal barrier attached to the foam before the lumber is attached. The contractor will need to know what exterior finish is going to be used on the wall before mounting the meter panel. For finishes other than brick the meter panel will mount on the exterior of the NUDURA Integrated Building Technology by first installing 5/8" (16 mm) or 3/4" (19 mm) exterior grade plywood, slightly smaller than the size of the panel. Then anchor back through wood shims to the concrete with galvanized concrete screws. If the breaker panel is located on the opposite side of the wall; create a circular cut out in the plywood to fit the wall sleeve, and mount the meter panel to the plywood with galvanized screws.

10.4 WIRE CHASES

After the NUDURA walls are completed, poured, and typically the roof has been completed, the wire chases can now be cut into the EPS. Of the many tools used to cut a wire chase, the three fastest and cleanest are an electric chainsaw, hot knife, and reciprocating saw.

- **Chainsaw:** To make a depth stop on a small electric chain saw, measure the depth of chase required back from the tip of the chain, drill a hole in the bar, install a 3/8" (10 mm) diameter x 3" (76 mm) long all thread rod, and nut each side. This prevents the chain from extending to far into the foam and hitting the concrete. The width of the bar and chain make an ideal chase for the wiring to fit snugly into the EPS.
- **Hot Knives:** These often come with a depth stop clamping plate along with various metal cutting blades that can be bent to create any width or profile needed to create the chase. One downfall to the hot knife is ensuring the blade maintains a constant heat to melt the EPS. The hot knife technique is ideal for cutting out the boxes as it has the ability to create a smooth finish at the back of the cutout.
- **Reciprocating Saw:** The reciprocating saw can also be used to create a chase within the EPS. The contractor will have to modify the blade for depth as to not hit the concrete when the saw is in operation. The blade on the saw should be cut so that it will penetrate the foam no deeper than 2" (50 mm). An easy way to maintain straightness along the wall in the horizontal direction is to snap a chalk line and simply cut to the line. If cutting chases vertically the contractor simply has to follow the 2" (50 mm) cut lines on the forms.



FIGURE 10.03



FIGURE 10.04

Another thing to remember when the building is being constructed, before the attachment of the floor the electrician may want to layout the location of chases going between the rim joist and EPS. This can be a chase cut into the EPS or a piece of conduit mechanically fastened to the concrete.

10.5 ELECTRICAL BOXES

Both metal and plastic boxes can be used with NUDURA Integrated Building Technology. The cleanest cut out is accomplished after the pour with a hot knife box attachment, or using a heated metal box as a branding iron. Once the location for the box has been established and the required amount of EPS has been removed, it is recommended to run wires into the box prior to anchoring the box to the wall.

Boxes with a stud flange can be screwed to the polypropylene fastening strips located every 8" (203 mm) on center. Other box types can be anchored through the back of the box to the concrete with a concrete screw or nylon plug and screw combination. Should a box require multiple wires within it, the electrical code or authority will dictate the number of



FIGURE 10.05

allowable wires that can be installed within a box. When a multi-gang box is required, additional mechanical fastening into the concrete might be required. Again check with the local electrical authority on the number of wires that are allowed within these boxes.

The use of sealed vinyl boxes is recommended to aid in mitigating the transfer of water vapor into the box. Although NUDURA always purports that an additional vapor barrier is not required on EPS, once the EPS has been cut to install the box, the overall thickness has been compromised and therefore a vapor barrier is needed where the box is located only. If a metal box is being used, consider fitting the hole with pre-molded polyethylene box inserts prior to installation of the box and taping this insert to the face of the foam with approved air/vapor barrier tape.



FIGURE 10.06

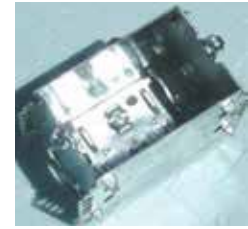

FIGURE 10.07

10.6 ELECTRICAL WIRING (NM OR NMD TYPE)

Tucking Romex/Lomex (non-metallic sheathed, NM or NMD) type wire into a snug fitting chase is the easiest method of keeping a wire in place. Wider chases will require NUDURA low expansion spray foam to be used in the chase to hold the wire back. Should the low expansion spray foam not be available, a clip that can be mechanically fastened to the concrete will be necessary. Remember to follow the applicable Electrical Code or Electrical Safety Standards for your region. Most North American Codes require a minimum of 1¼" (32 mm) clearance between the outer most surface of the embedded wire sheathing and the backside of the thermal barrier material that's protecting the EPS foam of the NUDURA form surface. As with traditional residential construction, wherever this is NOT possible, a protective galvanized metal plate shall be installed in front of the wire wherever the wire is (for some reason) required to be closer to the form surface than the above noted dimension. This serves to protect the wiring from accidental penetration by contractors who would be applying interior wall finishes after electrical installations have been completed. Some Codes require a secure anchor on the wire within 8" (203 mm) of a box. As staples will not work in foam or concrete, use a small nylon cable zip tie or cable clamp with a manufactured eyelet to accept a short concrete screw, or simply use low expansion spray foam to secure the wire into the chase at the box.

10.7 CONDUIT

Metal or plastic conduit can also be installed into NUDURA forms in the same manner as Romex/Lomex™ cables are, within cut chases after the pour. When electricians are on the job every day, plastic conduit can be embedded directly in the wall cavity and encased in concrete. Embedding conduit in the cavity requires a 90° piece of conduit and the box to be installed prior to the pour. The box is typically mounted to a shimmed out plywood patch which is screwed to the face of the plastic webs to allow the box to extend beyond the face of the foam. It is far more efficient, and less expensive, to run conduit in the foam, after the concrete pour (if conduit is necessary). Remember, however, that conduit run in this manner must be mechanically anchored with clips and screws into the concrete core.



FIGURE 10.08

10.8 RECESSED LIGHTING AND OTHER TYPE OF CEILING FIXTURES INSTALLED WITH NUDURA CEILING TECHNOLOGY

Prior to any installation of the NUDURA Ceiling Technology, pre-planning placement of any lighting fixtures must be completed to ensure the proper support has been provided for the required fixtures. Recessed pot lighting will require a plywood box finished with drywall to be built to dissipate heat from the pot light. Follow the pot light manufacturer's recommendations for size and depth of the box. Remember that since clearance above the lamp will be required, the box will have to be insulated to the same level as the Ceiling Technology on both side and top, projecting above the ceiling chords of the truss or ceiling joists. Note: Consult local building code for required installation levels.

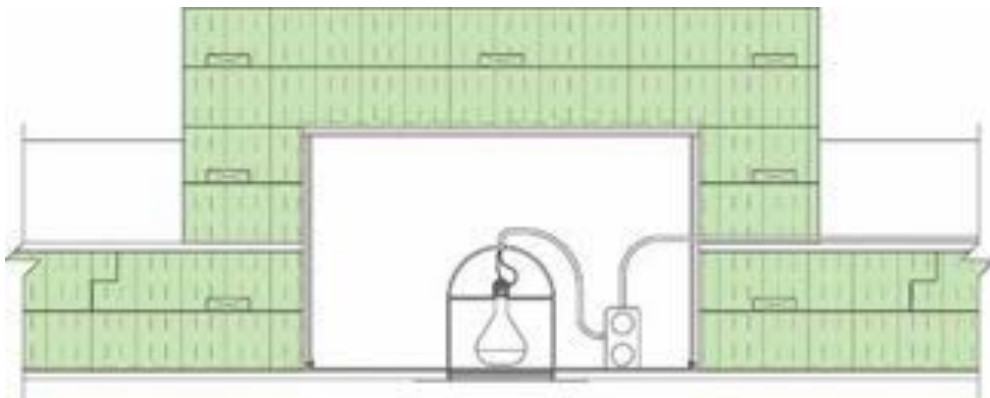

FIGURE 10.09

Ceiling fans should have additional solid support to limit the movement of the solid stem of the fan during operation. A length of solid threaded steel rod fitted with washers and nuts that is attached to the ceiling joist will provide the necessary support to prevent additional movement. Additional wood blocking will also help to reduce movement of the fixture during operation. Again the blocking will have to be secured to the ceiling joist or truss chord above.

Finally heavy fixtures such as chandeliers might require solid blocking to the ceiling joists as well that are capable of resisting the additional weight of the fixture. Again a solid threaded steel rod can be used for this application. Solid blocking the entire depth of the insulation may also be used to support the weight.

One thing to note is that should the method being used penetrate through the entire depth of the insulation, a vapor barrier will be required around that penetration, connected onto the surrounding ceiling technology, to prevent moisture from escaping through this area.

11.0 MECHANICAL

As with all buildings, the mechanical equipment installed must work efficiently with the type of structure being proposed. Inefficient equipment will result in poor performance of the structure and increased costs to the end user. When sizing any mechanical equipment it is beneficial to calculate, through engineered analysis, the required size of heating equipment along with the appropriate cooling equipment. Calculations should include the orientation of the structure to the prevailing winds, the amount of glazing within the building, floor areas to be heated or cooled, and finally the under slab insulation, type of wall insulation and roof insulation. All of these need to be calculated in order to effectively calculate the size of the mechanical system. According to the Portland Cement Association, most ICF Buildings fitted with a proper mechanical system will save an average of 44% on heating costs and 32% on air conditioning costs. When combined with other energy efficient building elements – some NUDURA buildings have been recorded to save as much as 50% over conventionally constructed buildings of similar size in the same location.



FIGURE 11.01



FIGURE 11.02

When calculating the wall insulation, NUDURA's EPS has an R-Value of 23.59 Btu/ (ft²·hr·°F) (RSI 4.13 m²·K/W) (U-Value 0.242 W/m²·°K). This is based mainly upon the EPS foam, but when taking into consideration the solid mass of concrete sandwiched between the two 2 5/8" (67 mm) thick panels, the overall performance of the wall assembly increases significantly depending upon geographical location. These performance values are available through ASHRAE 90.1 documents according to cities throughout North America. When trying to understand the overall performance of a wall section it is beneficial to know the difference in degree days for the region over a 12 month cycle. The lower the difference in the number of degree days in a 12 month cycle, the higher the overall performance of the wall. For example; if a structure was built in Southern Florida the difference in temperature change over 12 months might be 50°F (10°C), but in Northern Canada the temperature difference would be more like 90°F (33°C). This means that the overall wall performance will be reduced in Northern Canada due to increased temperature swing over the course of 12 months.

The other key component to consider is the amount of heat loss that normally occurs through a NUDURA Integrated Building Technology wall. Under typical sustained Canadian winter conditions, the heat loss through a NUDURA wall is about 3 Btu/hr/ft² (9.465 W/hr/m²). NUDURA's ceiling technology has a heat loss of 2 Btu/hr/ft² (6.31 W/hr/m²).

The question then remains in mechanical design, what should the mechanical designer input as the design R Value when performing heat loss calculations for a NUDURA Building? Though it will be higher than R22, the exact value cannot be calculated without the advice of an ICF experienced designer for your region. Nonetheless, experience has repeatedly shown that mechanical system designs that fail to adequately consider the thermal mass, continuous insulation, and air tightness properties of an ICF Assembly will generally perform much more in-efficiently than designs that do reflect the ICF's true thermal mass performance for a given geographic region.

For guidance on this subject, refer your mechanical designers to support resources available for mechanical designs for insulated concrete form buildings from the Portland Cement Association or the Cement Association of Canada at these links:

<http://www.cement.org/>
<http://www.cement.ca/>

MECHANICAL

There are also selected mechanical engineering and design firms throughout North America who do understand the science of thermal mass performance of ICF Technology and are producing energy efficient systems that have been properly integrated, with NUDURA as the exterior envelope. Some companies even offer guarantees for mechanical performance of the building.

A properly designed mechanical system will ensure longer cycle times of operation for the mechanical equipment that assures more air exchange is occurring to properly ventilate the building. This is particularly important in the cooling cycle where adequate air exchange is necessary to assure that the full volume of air for the building is being passed through the system, so that condensation is not resulting on any surfaces in the building interior.

For some climatic zones, and because NUDURA buildings are extremely airtight, the design of the mechanical system may involve use of a Heat Recovery (HRV) or Energy Recovery (ERV) Ventilation System. These systems cleverly use the ambient air from the building to help heat or cool any fresh air being supplied from the exterior. The added benefit is that these systems also balance the flow of ventilation air within the building to prevent back draft conflicts with other mechanical devices in the building, such as gas or oil fired furnaces, hot water heaters or even naturally vented fireplaces. A ventilation system is required, usually by code, to exchange air within a building and refresh it with clean, outside air. Typical air exchanges in a NUDURA built structure should be roughly 1 per hour, but different building sizes will dictate the number of exchanges necessary for the structure.

Be sure to review these aspects of the system design with your mechanical contractor prior to their bid, to ensure that the mechanical system for your building is properly sized.



FIGURE 11.03

12.0 PLUMBING

GENERAL

In traditional building methods, plumbing installation practices generally maintain that whenever possible hot and cold supply waterlines should be kept to the interior partition walls or within floor spaces under cabinets, tubs and sinks. With NUDURA's Integrated Building Technology the same rules will apply. By running the waterlines and any vent stack pipes through interior partition walls will not jeopardize the EPS insulation on the exterior walls and it will reduce the risk of freezing in cold climates. All plumbing codes must be followed with regards to waterlines, vent stack pipes, and waste piping.

In Section 6.7 (Service Penetrations) this manual discussed the need for installing sleeves and inserts prior to concrete placement for a variety of different mechanical, electrical, and, of course, plumbing needs. If copper piping is used for water supply, the plumber is cautioned to ensure that all EPS foam is protected from open flame especially if sweating copper joints at or near the foam surface by using sheet metal or other means.

The NUDURA Installer and/or Project Supervisor should note that for any NUDURA job requiring standard wood, engineered wood joists, floor trusses or light framed metal floor systems, despite ideal installation conditions as discussed above, the Plumber MAY require access to specific wall locations AFTER the concrete walls have been poured and BEFORE the floor system is hung to enable access for any plumbing runs that may need to transition a floor level that is installed inside the NUDURA wall. If the Plumber cannot access the site before the floor is installed, the Project Supervisor can identify the area where penetrations may be required and install PVC or ABS vertical vent pipe sections that extend sufficiently above and below the project floor level to accommodate the plumber's access behind the floor joists at a later date.

WATER SUPPLY

Despite best recommended practices above, should the building design dictate the need to run water lines in the EPS, a chase the size of the piping will be necessary to be cut at the required location. The chase can be cut in after the NUDURA walls are completed poured and the roof has been finished. Just as cuts are made for creating chases for electrical wiring, the same is true for water supply lines that need to be installed in NUDURA. Chain Saw, Reciprocating saw or Hot Knives will all work effectively, however, for water supply lines, it's best to use a hot knife to cut the chases – and ONLY as deep as required to keep the pipe insulated behind to its maximum level and tight to the backside of the finish or as close as Plumbing Codes will permit. This will reduce risk of freeze-up in colder climates. Be sure to keep the piping away from web locations so that there is no danger of fasteners penetrating the pipe.

For extreme climates where temperatures will fall below the freezing point, a non-freeze hose bib should be installed. If this is not available, then a shut off valve with drainage capabilities can be installed for exterior hose bibs. Should the through wall service penetration be installed prior to concrete placement, NUDURA recommends that the piping used for the penetration extend beyond the face of the EPS on both sides of the wall as to accept couplers at a later date.

WASTE WATER DRAINAGE AND VENTS

As with most conventional buildings, the main toilet waste water drains and vent stacks will typically be 4" (100 mm) PVC or ABS pipe. If they do not extend outward BELOW the footing, they will have to extend through the wall at the elevation necessary to direct the waste water by gravity to either the septic tank and bed or street sewer line. These through-wall penetrations will need to have extra care taken around the pipe extending past the outside of the wall to ensure leaking from surface water will not penetrate through the wall at these locations. An EPS capable primer or caulking around the penetration before the peel and stick membrane is applied, will seal any areas around the sleeve and prevent surface water migration from getting through the wall section.

As discussed earlier with water supply, despite the most ideal planning, inevitably the situation will arise where waste water vents and pipes will require installation within a NUDURA Wall.

NOTE that the EPS foam in a NUDURA insulated panel has a MINIMUM foam thickness (due to the vertical dovetail channels on its interior concrete facing surface) of 2 ¼" (57 mm). This means that the MAXIMUM inside diameter ABS or PVC Vent pipe that can be installed in the wall including coupling fittings will be 1 ½" (38 mm).

If a vertical waste stack is required to be installed at a NUDURA wall, there are 3 options for installation. These are:

1. Non-recessed stack with full chase finish around
2. Partially recessed stack cut into foam – post concrete placement
3. Fully recessed stack partially intruding into concrete core



FIGURE 12.01

Non-recessed and partial recessed stack options do not need any special planning or preparation prior to concrete placement. The downside however, is that they will result in the interior finish surface having to be chased around the pipe to accommodate them which may NOT be the most ideal for your end use client.

Full recessed vent stack pipes will need to be pre planned before any concrete is poured into the wall section, but the added advantage is they visually do NOT intrude into the interior space. The vent stack pipe size should not exceed more than ⅓ of the depth of concrete core being used for the wall thickness. This ensures that the solid concrete wall will not be jeopardized, structurally from the vent stack requirement. In the pre-planning operation, foam inserts cut to size as shown in Figure 12.02 are foamed into place during the form installation at the required stack location and marked for later reference. Remember that additional vertical reinforcement will be required for the concrete behind this area and care will have to be taken to ensure that horizontal reinforcement is maintaining a minimum 3'4" (1016 mm) clearance from the foam surface of the insert.

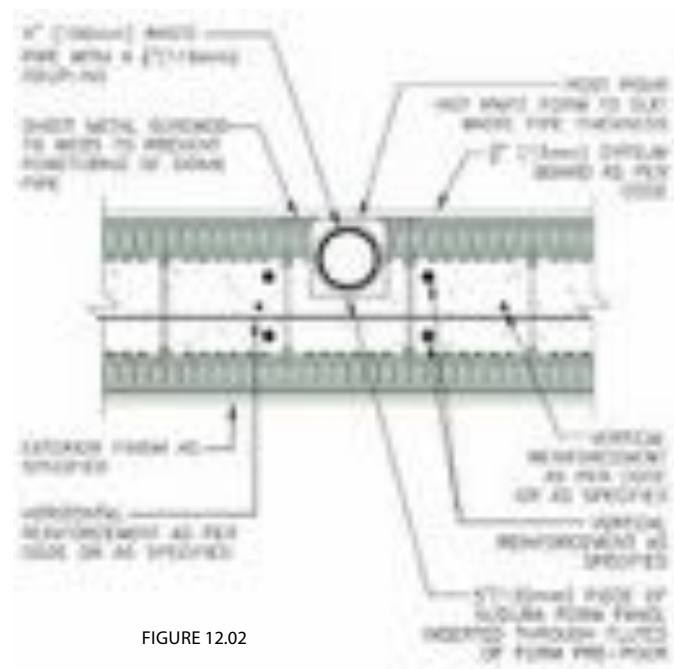

FIGURE 12.02

Once plumbing work begins either the plumber can either saw or hot knife cut the foam clear and install the vent stack in place and anchor (per code requirements) the vent stack in place inside the chase.

Remember that, should larger diameter drains or vents that 1 ½" (38 mm) need to be run in the interior EPS panel of NUDURA forms, with careful planning and marking for later access by the plumbing contractor, the same foam insert technique discussed above can be used as may be necessary.

13.0 INTERIOR FINISHES

13.1 VAPOR BARRIER/VAPOR RETARDER REQUIREMENTS

As with all traditionally constructed buildings, the interior finishes for a NUDURA building can vary throughout the world. What might be very common in one region might not be available in another. As with EPS (expanded polystyrene) the material typically must be covered with a thermal barrier if the space is considered habitable by the local building codes.

One of the most common questions asked by both design professionals and building officials with respect to NUDURA Integrated Building Technology is whether or not an additional vapor barrier or vapor retarder is required to be applied over the interior surface (or depending upon geographic location – on the exterior) of the NUDURA Wall System.

The clauses of most American Building Codes (including the International Code Family) are structured in such a way that they provide for the fact that plain and reinforced concrete or masonry walls constructed in accordance with the Code (or constructed of materials that are not susceptible to damage from moisture) are not required to have additional vapor retarder materials applied to them. In the USA, Vapor Retarders are defined as any material that limits the permeance of moisture through an assembly to a maximum of 1 perm-inch (57.692 ng/Pa.s.m²).

The MAXIMUM allowable vapor permeance of a wall assembly in Canada under the National Building Code and all Provincial Building Codes is noted as 60 ng/Pa.s.m² (nanograms per Pascal second meter squared) almost identical to the requirement of the US Code.

NUDURA's Integrated Building Technology has been analyzed by Intertek Testing Services North America Ltd., who have confirmed that the calculated vapor permeance of the 2 5/8" (67 mm) thickness of NUDURA foam on the interior panel of the concrete wall assembly achieves a MAXIMUM vapor permeance of 36 ng/Pa.s.m². Using the same conversion rate applied above, verifies that the Permeance Rating of 2 5/8" (67 mm) of NUDURA EPS foam is equal to 0.624 perm inches and therefore achieves a resulting vapor permeance performance that is 38% better than the MAXIMUM allowable vapor permeance set forth by both Canadian and the US International Building Codes.

Remember that this rate has been determined independent of any resistance to vapor permeance that the monolithic concrete wall itself provides within the wall assembly. Therefore, in the vast majority of installations, an additional vapor barrier is NOT REQUIRED, except as previously noted in Chapter 9 to complete vapor barrier elements around building openings.

The ONLY exceptions to this rule should apply in areas where high humidity will ALWAYS be prevalent (i.e. indoor pools or saunas etc.) AND where a finish applied may be in danger of trapping moisture behind it such as ceramic tile, vapor sealed paints and wallpapers. In such areas an additional vapor barrier capable of reducing vapor permeance to a maximum of 0.260 Perm-Inch (or 15 Ng.Pa.s.m²) is recommended, and is a requirement by Canadian Code.

13.2 THERMAL BARRIER PROTECTION

Most building codes state that all foam plastic insulation must be covered with an approved thermal barrier. In Canada, the specified standard under the NBC (CAN/ULC S-101) requires that the thermal barrier must prevent a rise in temperature of the EPS foam behind it to below an average of 284° F (140° C) as recorded at 10 minutes from the start of the test. In the USA, the thermal barrier test is less severe and conducted to a completely different standard (NFPA 275), but requires that



FIGURE 13.01



FIGURE 13.02

there be no evidence of edge melting of the EPS foam, or de-lamination of the thermal barrier after 15 minutes of testing. Individual provinces or states may have bylaws or Codes that increase the time that the thermal barrier has to stay in place. Please check with the regional code bodies for their interpretation of thermal barrier, and stay in place requirements.

Building codes will also require that the thermal barriers be installed where the space is considered habitable living area. Check with the local building department as to the interpretation of habitable living area (i.e. below grade full height foundations). NOTE: The contractor should review this carefully with a client who requests that their basement be supplied un-finished in the contract. In many areas, the Building Official for the region may insist that the thermal barrier be installed as a condition of final occupancy. Should this be necessary, most building officials will permit horizontal gypsum board installation, with joints remaining un-taped so that the wall areas can be easily accessed later for electrical installation with minimum disturbance of the gypsum board. Responsibility for the expense for this compliance should be agreed upon by client and contractor PRIOR to the start of the contract.



FIGURE 13.03

Thermal Barriers can include some of the following products: ½" (13 mm) gypsum wall board, ½" (13 mm) plywood, ½" (13 mm) tongue and groove wood, plaster finishes, or any material that, by code, can provide testing over EPS foam plastic to the applicable standard adopted under the prevailing code for the area. It is always recommended to check in the local codes for a list of materials recognized as meeting these requirements.

13.3 FINISHES AND TRIM OPTIONS

Before finishes are applied to the NUDURA EPS the contractor/installer needs to take into consideration some additional fastening requirements needed for hand rails, curtain rods, heavy wall hangings (i.e. large mirrors, heavy artwork), upper kitchen cabinets, and handicap bathroom rails. These can consist of solid blocking mechanically fastened to the concrete, or light gauge metal mechanically connected to the fastening strips.

In many instances, the ideal scenario is to rip 4" (102 mm) wide (or wider if needed to suit application) segments of ½" (13 mm) thick plywood for the regions where fastening will be required as noted above (such as horizontally in line with the anchor reinforcement boards of upper cabinets in kitchen areas). Using a hot knife attachment formatted for this purpose, rake any EPS foam clear to the level of the fastening surface of the webs. Then, cut the plywood segments to the required length and screw fasten them with No. 8 flathead coarse thread screws into the webs of the inset areas that have been raked clear with the hot knife. You now have solid continuous fastening exactly in line with whatever trade arrives AFTER the drywall trades have finished their work AND no disruption or special requirements imposed on the drywall contractor.



FIGURE 13.04



FIGURE 13.05



FIGURE 13.06

NUDURA recommends that the interior finish materials used be mechanically connected to the fastening strips using screws. Should the contractor decide to use ½" (13 mm) gypsum wall board or plywood, NUDURA recommends the wall board be fastened onto the wall using a 1 ⅝" (41 mm) minimum coarse thread drywall screw. For all other finishes the manufacturer's installation instructions need to be followed. However, if the manufacturer recommends the finish be nailed in place, contact the local distributor for assistance and NUDURA will work with the finishing company to find a suitable type of screw for fastening.

Windows and doors can have different options for jamb materials as previously discussed in Chapter 9 of this manual. Fastening will depend upon the buck material used when the opening was created or if the buck material was removed then fastening to the concrete will be required. Trim casing can be fastened to the jamb and gypsum wall board using a combination of adhesive and nails. Pneumatic air nailers can be used for the inside trim work where required. Using caulking, and also nailing the mitered corners together will ensure a tight finish. Gypsum wall board can also be used as the jamb material for finishing out the openings.

Baseboards can be fastened directly to the gypsum wall board using a combination of adhesive and nails. Should the contractor decide to attach a band of plywood the same thickness as the gypsum wall board this needs to be completed before the wall board is installed. The band of plywood height should be approximately 1" (25 mm) less the height of the baseboard material. Again, pneumatic nailers can be used in this finishing process.



FIGURE 13.07



FIGURE 13.08

13.4 POST OCCUPANCY FIXTURE MOUNTING TIPS FOR HOME AND BUILDING OWNERS

Once an owner takes occupancy, if a contractor should ever be asked for anchorage tips on how to work with NUDURA for a home renovation or "Do It Yourself" job, refer to the following pages. This answers most typical questions posed by building owners on this subject. Any additional questions not addressed by this bulletin can be directed to NUDURA through your local distributor.

INTERIOR FINISHES

NOTE TO THE CONTRACTOR

The following information is provided here in your manual to assist you in addressing questions from your end use client who may be encountering living/working in a NUDURA home or building for the first time and may not be fully familiar with the differences between traditional wood frame or furred out concrete block technology and ICF Wall Technology in the context of adding decorations, fixtures or cabinets to their new home or building. Should any question arise that is NOT covered in this brief summary of topics, please contact NUDURA through your distributor. NUDURA's staff will work to get the answers you require.

POST INSTALLATION FIXTURE AND CABINET ATTACHMENT METHODS INTO FINISHED NUDURA WALL ASSEMBLIES

One of the first questions that comes to mind of any new owner or operator of a NUDURA structure (particularly if you have never had any experience with or knowledge of Insulated Concrete Form Systems) – is: How do I attach fixtures, decorations or cabinetry to the walls?

To understand better how NUDURA affects this process, you first have to know how NUDURA walls differ from traditional frame or strapped block walls.

Unlike traditional wood stud, metal frame or even furred out concrete block wall construction. Instead of studs (furring strips) and hollow space behind the gypsum board finish, the plan view of a NUDURA wall looks similar to the detail shown at right – which consists of a solid 2 5/8" (67 mm) thickness of expanded polystyrene foam plastic insulation backing the entire wall surface over a solid reinforced concrete core. At 8" (203 mm) intervals, there are a series of vertically placed 1 1/2" (38 mm) wide x 3/16" (5 mm) thick high density high impact polystyrene plastic web fastening strips (each embedded below the surface of the EPS foam about 1/2" (12.7 mm). This very tough high-impact plastic is capable of holding screws to an ultimate direct pullout withdrawal pressure of anywhere between 210 to 275 lbs (0.934 to 1.223 kN) of force.

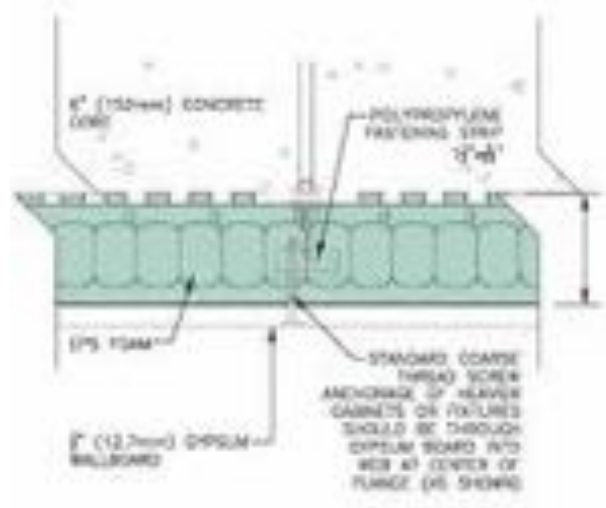

Q: HOW DO I TELL WHERE A FASTENING STRIP IS LOCATED?

Contrary to popular opinion, an electronic density stud finder will not always work with NUDURA walls since, the fastening strips are embedded 1/2" (12.7 mm) below the foam surface – and as a result, the webs won't ALWAYS reveal themselves when scanned through drywall finish.

Probably the best method for locating studs is by using a magnetic stud finder which, instead, locates the drywall screws that are anchoring the drywall to the fastening strips. Once ONE screw is located, most fastening strips can then be located at 8" or 16" (203 mm or 406 mm) centers from this screw. If you lose the pattern (i.e. wherever the NUDURA installer varied from the standard 8" (203 mm) stack pattern to accommodate a custom cut joint along usually near the center of a wall length), you can be certain that for most rooms, the pattern of webs will be at a constant 8" (203 mm) increment starting 1/2" (12.7 mm) away from a 90 degree corner (the web pattern starts with the center of web fastening strips being located starting this distance from the inside corner conditions).

Q: FOR LIGHTWEIGHT PICTURES, ETC. CAN I STILL USE NAIL OR PIN TYPE HANGERS ?

Yes: Most light or medium duty drywall type picture hangers that do NOT rely on anchorage directly into wood or metal studs or strapping that you have been use to using for drywall finishes over standard frame construction can still be used with NUDURA walls as well. Finishing nail, pin hangers, plastic plugs, even expansion sleeve screws etc. will all still work with NUDURA when anchoring into drywall between the web flanges. Only spring type clip fasteners that relying on spring loaded cams opening behind the gypsum board finish will not work with NUDURA since the EPS foam will prevent the cam from springing outward behind the panel.

Q: FOR HEAVIER WEIGHT ARTWORK, WALL DECORATIONS OR FIXTURES, ETC. WHAT SHOULD BE USED ?

Use screws (not nails). No. 6, No. 8 or No. 10 dia. coarse thread screws (11-14 threads per inch (25 mm)) with a sharp penetration point should be used. Remember that the shaft length needs to penetrate BOTH the drywall and a ½” (12.7 mm) thickness of EPS foam PLUS the fastening flange to embed into solid anchorage so 2” (50 mm) long screws work best. The larger diameter the screw - the more holding power can be attained. With a 3 times safety factor applied, use the following table as a guide for maximum hold pressure for each type of screw being used for anchorage:

Screw Diameter	Tested Ultimate Withdrawal	Suggested Factored Safe Load
No. 6	210 lbs. (0.934 kN)	70 lbs (0.311 kN)
No. 8	240 lbs. (1.068 kN)	80 lbs (0.356 kN)
No. 10	275 lbs. (1.223 kN)	90 lbs.(0.400 kN)

When fastening - simply snug the screw against whatever is being mounted over the drywall (such as a bracket or clip). If a finish harder than drywall is used (i.e. perlite plaster over lath or concrete board) - do NOT over-tighten screws as this can cause the screw to burr out the plastic of the webs.

Q: I AM MOUNTING A CLOSED IN BACK CABINET WHICH WILL EXERT MORE WEIGHT PER SCREW THAT I SEE IN THE ABOVE TABLE. HOW CAN I MOUNT THIS TYPE OF CABINET?

If a new cabinet or similar heavy storage device is being considered for mounting (i.e. an object with a closed backing and solid wood or metal mounting bars or brackets) and you calculate that 4 screws will NOT be enough to anchor the object, consider replacing the drywall with plywood behind the cabinet. Simply outline the proposed location of the cabinet with a lightly drawn pencil mark on the drywall.

Then draw a line inboard ½” (12.7 mm) all around from the projected outer edge of the cabinet and make a clean cut of the drywall at this mark full depth of the drywall using a utility knife. Next, locate & remove the screws in this area using a Philips head screw driver so that the webs are not damaged and, finally, remove the drywall. Replace this section with ½” (12.7 mm) thick plywood and anchor to the webs (identified by a “diamond” pattern in the foam surface) with as many screws as may be required to hang the object with sufficient safety factor to be less than 90 lbs (41 kg) per No. 10 screw. Finally, remount and level the object and secure with screws in position through the plywood to firmly anchor the object to the wall. The plywood will be completely concealed by the object.

Q: I AM MOUNTING A PLASMA OR LCD TV WHICH WILL EXERT MORE WEIGHT PER SCREW THAT I SEE IN THE ABOVE TABLE. HOW CAN I MOUNT THIS TYPE OF FIXTURE?

If it is a plasma or LCD TV mounting bracket that is being anchored, use the mounting bracket as a template and align the wall mount studs of the mounting bracket with the NUDURA fastening strips. Most mounting studs will provide options for more than 2 screws (vertically in line) per mount. Follow the instructions provided for your mounting bracket. Depending on bracket design and configuration, if it is a movable or pivot mount design that enables the screen to be moved or pivoted away from the wall, the amount that your screen weighs should be multiplied by a specific factor noted in your bracket manual to account for the addition moment condition that will be created when pivoted away from the wall (NOTE: Standard US based measure only is used for the calculation example given below). Whatever the maximum factored weight of the unit will be fully extended, divide this weight by 90 lbs (41 kg) /screw limit. This will tell you how many No. 10 screws will be required to anchor the wall mount studs to the NUDURA wall.

For example, if the unit weighs 200 lbs (91 kg) and the bracket mount instructions suggest that fully extended the screen will exert a force 3 times greater; 600 (272 kg) divide 600 (272 kg) by 90 (41 kg) = 6.7. In this case it's best to mount using 8 screws - 2 per corner of the mounting frame for a total safe factored weight carrying capability of 720 lbs (326 kg).

Q: WHAT IF WHAT I AM ANCHORING IS TO A SINGLE POINT LESS THAN 1 FOOT SQUARE (0.09 METER SQUARE) AND ANTICIPATING A FORCE IN EXCESS OF 360 LBS (1.6 KN)? HOW CAN I MOUNT THIS TYPE OF FIXTURE?

In instances like this, again the gypsum board may have to be removed and replaced with a square of plywood so that the plywood segment spans at least 2 fastening strips. Anchor the plywood with the appropriate number of countersunk screws to resist the weight and finish the plywood joints and screw embeds with drywall compound to blend it in with the drywall and finish and paint to match the space. Now the object can be mounted to the plywood as required.

If even more anchorage strength would be required, consider the above solution in conjunction with removal of the foam below the plywood and custom cut blocking that is lag bolt mounted directly to the concrete behind the plywood.

Any questions further to this information should be directed to NUDURA through your local NUDURA distributor. Together, we will work with your distributor to find an anchorage solution to fit your specific needs.

14.0 EXTERIOR FINISHES

14.1 GENERAL

NUDURA's Integrated Building Technology can be covered with a multitude of different finishes. Exterior finishes must be installed over the EPS in accordance with the building code and local requirements. The exterior finish will protect the EPS from the elements and nature. The contractor must follow the finishes installation guidelines for installation onto the EPS forms.

MOST IMPORTANT: All exterior finishes requiring mechanical attachment will require the use of SCREWS in place of any nails that are specified in the manufacturer's installation instructions.

As noted previously in Chapter 9, an area of finishing that needs special attention will be around the openings and the proper installation of rain screens, drip cap flashings, through-wall flashings, sill pans, and air barrier membranes, that prevent moisture from entering in behind the opening and ultimately gaining access to the inside of the building. The exterior finish will determine the type, and method, of rain screen or drip edge membrane. Stucco applications will require the base coat to be wrapped into the window flange before finishing trims are attached. If the finish happens to be a material that is not directly applied to the EPS then light gauge metal kerfed into the EPS along with the NUDURA Peel and Stick Membrane will prevent any moisture from getting to the inside of the wall. These requirements are covered in more complete detail under Chapter 9. However, the contractor should be sure to cross check this data for completion of these details before ANY exterior finish material is applied.



FIGURE 14.01

Check local building code requirements for use of weather resistive barrier before installing an exterior finish on NUDURA ICF.

In the event that, for purposes of any local code compliance issues, or the project design architect should specify an additional air barrier to be installed on the exterior building face as either a water resistive barrier or second defense air barrier, materials that are acceptable for use with the NUDURA Integrated Building Technology **MUST NOT BE PETROLEUM BASED** (i.e. tar paper, asphalt impregnated paper or felts). Over time, these materials can potentially leach chemicals into the EPS that may react with the EPS resin. Acceptable products that are available as alternates for this purpose include spunbonded polyolefin fiber based breathable air barrier materials such as TYVEK® or TYPAR®. These materials are tested and approved air barriers designed for use where needed within the building envelope. They are specifically designed to safely shed bulk water, but remain vapor permeable.

14.2 FINISH MATERIALS

BRICK

Masonry brick or stone can be installed as a finished product onto the EPS material. A corbelled brick ledge form is required for support of the brick or stone. As stated in Chapter 6, section 6.9, the corbelled ledge can support the equivalent weight of 27' (8.2 m) of standard weight brick. Should a heavier brick or stone be specified for the exterior finish, the overall height will decrease to match the weight difference from the heavier materials. NOTE: It's important to remember that brick veneer will still require a through-wall flashing to be installed between the first course and the supporting ledge. Just as the drip cap flashings discussed in Chapter 9 must be kerf cut upward at a 45° angle into the foam, a minimum distance of 1" (25 mm) the same is true for brick veneer through-wall flashings installed at the top of a brick ledge or for a taper top form being used to support brick veneer. The flashing also needs to be sealed at all joints exactly the same as in conventional construction to ensure any bulk water that may get behind the cavity never penetrates into the ledge or tapered top form (see Figure 14.02).

In addition, brick ties will need to be connected to the fastening strips using screws at the recommended spacing dictated by code (usually 16" x 16" or 16" x 24" (400 mm x 400 mm or 400 mm x 600 mm) spacing. Should the brick extend over openings, a steel lintel will be required as per typical construction methods and sized as per prescriptive code requirements or as specified by the designer.



FIGURE 14.02

WOOD SIDING

Wood siding can be installed onto NUDURA's Integrated Building Technology either vertically or horizontally. The installation instructions of the siding manufacturer must be followed to ensure the warranty is covered. For example, if the building has been specified to have prefinished wood siding applied to the wall and the manufacturer's installation instructions require an air barrier and strapping to be applied to the wall in order to meet their warranty, then the contractor must follow these instructions. Vertical siding will require additional strapping attached, using screws, to the fastening strips of the forms.



FIGURE 14.03

CEMENT BOARD SIDING

Unlike wood siding which requires strapping, Cement board siding can be directly installed onto NUDURA's walls. This provides the continuous support that cement board sidings typically require. However, to be certain of specific requirements, (i.e. changing requirements for drainage, consult with the manufacturers' latest installation instructions that need to be followed for warranty purposes). Some manufacturers will recommend the siding to be nailed to the wall, however remember that NUDURA does require that the siding be screwed in place, as nails will not provide adequate holding power and also will not penetrate through the polypropylene fastening strips.



FIGURE 14.04

STUCCO

Stucco is a popular finish on NUDURA's Integrated Building Technology as it can be directly applied to the EPS, with no additional foam attached to the wall. As with finishes already discussed, the contractor will need to follow the stucco manufacturer's installation instructions to ensure proper techniques are completed. There are a few different types of stucco materials still being used in the construction industry, and all can be applied to NUDURA's Integrated Building Technology.

EIFS (Exterior Insulation Finishing System) is probably the most popular type of acrylic stucco coating available and is adapted specifically for application to Insulated Concrete Form Systems under the term DAEFS (Direct Applied Exterior Finishing Systems). This system is a 2 part product that has an acrylic makeup that allows the basecoat to bond to the EPS without a mechanically fastened wire mesh – and provides excellent flexibility for high temperature transition regions. A fiber mesh is still required but is embedded as the base coat is applied to the wall. One thing worth mentioning is that the stucco installer needs to properly rasp the EPS foam of the wall system first, to give the base coat a rough surface texture to bond properly to.



FIGURE 14.05

Traditional hard coat stuccos can also be applied to the NUDURA wall using the manufacturer's installation instructions. As stated with respect to other finishes, the wire mesh (or expanded metal lath) will need to be mechanically connected to the fastening strips using screws and NOT nails. As with acrylic based stuccos, the surface of the EPS usually needs to be rasped to ensure a strong bond of the base coat to the foam. Hard coat stuccos can vary in application method (either 2 coat or 3 coat systems – (i.e. Scratch, Brown and Finish coatings).

Instead of rasping the EPS foam surface -in some instances, the stucco installer MAY require a drainage medium to be installed behind the stucco. Consult with your stucco installer FIRST to determine what may be required. As stated earlier in this Section, remember that tar or asphalt based building paper is not suitable for application to NUDURA.

Another type of stucco is a 3 part stucco system. This finish requires the installation of a cement board onto the wall surface, a wire mesh, and finally the cementitious coat applied. The cement board will be required to be connected to the fastening strips using screws. An air barrier may be required for warranty purposes with this type of finish.

STEEL SIDING

Depending upon the manufacturer's installation instructions, strapping might be required to be connected to the wall before the steel siding is installed. If the siding is to be installed vertically then strapping is required, and needs to be attached to the fastening strips using screws. Building papers might be required as per the siding manufacturer installation methods but, as noted earlier, this needs to be a material that will not affect the EPS when in contact.



FIGURE 14.06

The siding must be attached to the NUDURA wall system using the manufacturer's approved screw. If available, a self tapping/self drilling screw will work best for direct attachment to the fastening strips.

VINYL SIDING

Like steel sidings and wood sidings, vinyl siding products must be installed as per the manufacturer's installation methods. Should the siding be directly installed into the NUDURA wall system, NUDURA recommends that the fasteners be screws, not nails. Additionally, if the siding manufacturer requires a building paper to be installed on the wall for warranty, then the paper needs to be a product that will not react with the EPS insulation. Also, should the installation techniques require that the building be strapped, these recommendations must be carried out as the siding manufacturers warranty might require it. NUDURA DOES NOT recommend pneumatic nailing for exterior finishes as the nails are much larger and potentially could damage the fastening strips.



FIGURE 14.07

THIN VENEER MANUFACTURED BRICK AND STONE FINISHES

As with all finishes, NUDURA Inc. always recommends that the product specified as a finish material for the building should be installed as per the manufacturer's installation instructions. Thin veneer stone and brick products by manufacturers such as Cultured Stone®, Kettle Valley®, or Natural Stone Veneers®, are not any different and will need to be installed as per the recommendations of each manufacturer. Most manufacturers have a set of installation procedures for their products, but NUDURA suggests the following procedures should be adopted for specifically adapting this process to the NUDURA form system:

- Install layer(s) of weather resistant barrier, per stone manufacturer's installation instructions, directly over exterior surface of the NUDURA form system
- Install manufacturer specified (re. gauge and style) wire mesh or expanded metal lath through EPS insulation into NUDURA fastening strips using #10 dia. X 2" (50 mm) long coarse thread pan head, self tapping thread screws complete with ½" (12.7 mm) washers
- Apply screws in an 8" (203 mm) o/c horizontal x by 12" (300 mm) o/c vertical grid pattern
- Apply manufacturer's recommended scratch coat over wire mesh to bond to weather barrier below the mesh
- Allow scratch coat to cure as per manufacturer's specifications
- Apply final mortar setting bed coat to scratch coat using materials and methods as outlined in the stone veneer manufacturer's installation instructions and, again, allow material to cure to specs
- Apply stone as per manufacturer's specifications to bond to mortar bed coat and final detail mortar joints once dry

The above noted methodology should be reviewed with the selected stone manufacturers' technical advisors to assure compliance to their latest endorsed methods of application over EPS (Expanded Polystyrene) foam surfaces OR to Insulated Concrete Form Systems, specifically NUDURA Integrated Building Technology.

OTHER MANUFACTURED FINISH OPTIONS

Though not common to all industry segments, other finishes may arise that are not specifically covered here. These may include novel brick or siding systems (i.e. Novabrik®, Centria® Finish Panels, Nichiha® Fibercement Panels etc.) Each has their own anchorage system that can be adapted to NUDURA with the right instruction and technical information. Should specialty systems arise, before installation starts, consult with your local distributor for NUDURA's specific assistance in working with the manufacturer for specifying the required attachment for each system.

In conclusion –the techniques represented here are intended for general installation guidance only. As with any exterior finishing material, NUDURA Inc. will always refer the contractor back to the finishes manufacturer's installation requirements to have them review and amend as required for their specific purposes, the procedures suggested here. NUDURA will not be held responsible for any finish material that is incorrectly installed onto its products. If an exterior finish should become defective before the expected life cycle of the product, NUDURA Inc. will not be held liable for any replacement of such material.